



# קטרטו

הפצה **WIDIA** ישראל



GSR

AGGUD

felo

UNIOR

morrisflex

WIDIA

serinex  
CNC TOOLHOLDER SYSTEM

Karnasch

Think threads with  
YAMAWA



ISO Vc (m/min)		ISO Vc (m/min)		Oversized
P2	≤10 ★	P4	≤10 ☆	
P3	≤10 ★	P7	≤10 ★	
		M1	≤10 ★	

★ 1st choice ☆ suitable

M	מק"ט	מחיר	UNC	מק"ט	מחיר
DIN 371			DIN 371		
M2X0.4	SD2.0EAGEX	₪ 160	No.4-4UNC	SDUN4HXGEX	₪ 175
M2.5X0.45	SD2.5FAGEX	₪ 136	No.6-32UNC	SDUN6JXGEX	₪ 135
M3X0.5	SD3.0GAGEX	₪ 109	No.8-32UNC	SDUN8JXGEX	₪ 135
	SD3.0GMGEX	₪ 136	No.10-24UNC	SDUNAMXGEX	₪ 132
M4X0.7	SD4.0IAGEX	₪ 109	1/4-20UNC	SDU04NXGEX	₪ 122
	SD4.0IMGEX	₪ 136	5/16-18UNC	SDU050XGEX	₪ 162
M5X0.8	SD5.0KAGEX	₪ 113	3/8-16UNC	SDU06PXGEX	₪ 187
	SD5.0KMGEX	₪ 140	DIN 376		
M6X1	SD6.0MAGEX	₪ 113	7/16-14UNC	SGU07QXGEX	₪ 231
	SD6.0MMGEX	₪ 140	1/2-13UNC	SGU08RXGEX	₪ 248
M8X1.25	SD8.0NAGEX	₪ 135	9/16-12UNC	SGU09SXGEX	₪ 356
	SD8.0NMGEX	₪ 164	5/8-11UNC	SGU10UXGEX	₪ 344
M10X1.5	SD0100AGEX	₪ 161	3/4-10UNC	SGU12VXGEX	₪ 494
	SD0100MGEX	₪ 196	7/8-9UNC	SGU14WXGEX	₪ 703
DIN 376			1-8UNC	SGU16XXGEX	₪ 1054
M8X1.25	SG8.0NAGEX	₪ 159	1 1/8-7UNC	SGU18YXGEX	₪ 1361
M10X1.5	SG0100AGEX	₪ 194	1 1/4-7UNC	SGU20YXGEX	₪ 1698
M12X1.75	SG012PAGEX	₪ 208	1 3/8-6UNC	SGU22ZXGEX	₪ 2143
	SG012PMGEX	₪ 243	1 1/2-6UNC	SGU24ZXGEX	₪ 2834
M14X2	SG014QAGEX	₪ 249	UNF		
M16X2	SG016QAGEX	₪ 315	DIN 371		
MF			No.10-32UNF	SDUNAJXGEX	₪ 143
DIN 374			1/4-28UNF	SDU04KXGEX	₪ 138
M6X0.75	SM6.0JAGEX	₪ 134	DIN 374		
M8X1	SM8.0MAGEX	₪ 158	5/16-24UNF	SMU05MXGEX	₪ 201
M8X0.75	SM8.0JAGEX	₪ 158	3/8-24UNF	SMU06MXGEX	₪ 207
M10X1.25	SM010NAGEX	₪ 189	7/16-20UNF	SMU07NXGEX	₪ 254
M10X1	SM010MAGEX	₪ 189	1/2-20UNF	SMU08NXGEX	₪ 286
M12X1.5	SM0120AGEX	₪ 243	9/16-18UNF	SMU090XGEX	₪ 394
M12X1.25	SM012NAGEX	₪ 243	5/8-18UNF	SMU100XGEX	₪ 397
M12X1	SM012MAGEX	₪ 243	3/4-16UNF	SMU12PXGEX	₪ 535
M14X1.5	SM0140AGEX	₪ 292			
M14X1	SM014MAGEX	₪ 304			
M16X1.5	SM0160AGEX	₪ 369			
M16X1	SM016MAGEX	₪ 369			

G(BSP)	מק"ט	מחיר
DIN 5156		
1/8-28	SVG0020GEX	₪ 221
1/4-19	SVG0040GEX	₪ 296
3/8-19	SVG0060GEX	₪ 410
1/2-14	SVG0080GEX	₪ 595
3/4-14	SVG0120GEX	₪ 960
1-11	SVG0160GEX	₪ 1692



ISO Vc (m/min)		ISO Vc (m/min)		ISO Vc (m/min)	
P1	≤10 ★	P4	≤10 ☆	M1	≤10 ★
P2	≤10 ★	P7	≤10 ★	M2	≤10 ☆
P3	≤10 ★			★ 1st choice ☆ suitable	

M	מק"ט	מחיר	UNC	מק"ט	מחיר
DIN 371			DIN 376		
M2X0.4	PD2.0EBGEX	₪ 155	7/16-14UNC	PGU07QYXGEX	₪ 226
M2.2X0.45	PD2.5FBGEX	₪ 132	1/2-13UNC	PGU08RYXGEX	₪ 253
M3X0.5	PD3.0GBGEX	₪ 106	9/16-12UNC	PGU09SYXGEX	₪ 348
	PD4.0IBGEX	₪ 106	5/8-11UNC	PGU10UYXGEX	₪ 352
M4X0.7	PD5.0KBGEX	₪ 111	3/4-10UNC	PGU12VYXGEX	₪ 504
M5X0.8	PD6.0MBGEX	₪ 111	7/8-9UNC	PGU14WYXGEX	₪ 718
DIN 376			1-8UNC	PGU16XYXGEX	₪ 1078
M8X1.25	PG8.0NBGEX	₪ 155	UNF		
M10X1.5	PG0100BGEX	₪ 190	DIN 371		
M12X1.75	PG012PBGEX	₪ 203	No.10-32UNF	PDUNAJYXGEX	₪ 139
M14X2	PG014QBGEX	₪ 244	1/4-28UNF	PDU04KYXGEX	₪ 135
M16X2	PG016QBGEX	₪ 307	DIN 374		
MF			5/16-24UNF	PMU05MYXGEX	₪ 178
DIN 374			3/8-24UNF	PMU06MYXGEX	₪ 203
M8X1	PM8.0MBGEX	₪ 154	1/2-20UNF	PMU08NYXGEX	₪ 279
M10X1.25	PM010NBGEX	₪ 184	9/16-18UNF	PMU090YXGEX	₪ 323
M10X1	PM010MBGEX	₪ 184	5/8-18UNF	PMU100YXGEX	₪ 365
M12X1.5	PM0120BGEX	₪ 237	3/4-16UNF	PMU12PYXGEX	₪ 534
M12X1.25	PM012NBGEX	₪ 237	7/8-14UNF	PMU14QYXGEX	₪ 801
M12X1	PM012MBGEX	₪ 237	1-12UNF	PMU16SYXGEX	₪ 1198
M14X1.5	PM0140BGEX	₪ 286	G(BSP)		
M16X1.5	PM0160BGEX	₪ 360	DIN 5156		
UNC			1/8-28	PVG0020GEX	₪ 218
DIN 371			1/4-19	PVG0040GEX	₪ 292
No.4-40UNC	PDUN4HYGEX	₪ 172	3/8-19	PVG0060GEX	₪ 405
No.6-32UNC	PDUN6JYGEX	₪ 132	1/2-14	PVG0080GEX	₪ 588
No.8-32UNC	PDUN8JYGEX	₪ 132	3/4-14	PVG0120GEX	₪ 960
No.10-24UNC	PDUNAMYXGEX	₪ 129	1-11	PVG0160GEX	₪ 1692
1/4-20UNC	PDU04NYXGEX	₪ 119			
5/16-18UNC	PDU050YXGEX	₪ 175			
3/8-16UNC	PDU06PYXGEX	₪ 183			



ISO	Vc (m/min)	ISO	Vc (m/min)	ISO	Vc (m/min)
P1		M1	5÷15 ★	S1	5÷10 ★
P2		M2	5÷15 ★	S2	5÷10 ★
P3	5÷15 ★	M3	4÷8 ★		
P4	5÷15 ★				
P5	5÷10 ☆				
P7	5÷15 ★				
P8	4÷8 ★				

★ 1st choice ☆ suitable



ISO	Vc (m/min)	ISO	Vc (m/min)	ISO	Vc (m/min)
P3	5÷15 ★	M1	5÷15 ★	S1	5÷10 ★
P4	5÷15 ★	M2	5÷15 ★	S2	5÷10 ★
P5	5÷10 ☆	M3	4÷8 ★	S3	3÷6 ☆
P7	5÷15 ★				
P8	4÷8 ★				

★ 1st choice ☆ suitable

M	מק"ט	מחיר	UNC	מק"ט	מחיר
DIN 371			DIN 371		
M3X0.5	SD3.0GBJPX	₪ 217	No.4-40UNC	SDUN4HYJPX	₪ 251
M4X0.7	SD4.0IBJPX	₪ 217	No.6-32UNC	SDUN6JYJPX	₪ 193
M5X0.8	SD5.0KBJPX	₪ 224	No.8-32UNC	SDUN8JYJPX	₪ 193
M6X1	SD6.0MBJPX	₪ 224	No.10-24UNC	SDUNAMYJPX	₪ 188
M8X1.25	SD8.0NBJPX	₪ 275	1/4-20UNC	SDU04NYJPX	₪ 183
M10X1.5	SD0100BJPX	₪ 330	5/16-18UNC	SDU050YJPX	₪ 259
DIN 376			3/8-16UNC	SDU06PYJPX	₪ 272
M12X1.75	SG012PBJPX	₪ 429	DIN 376		
M14X2	SG014QBJPX	₪ 541	1/2-13UNC	SGU08RYJPX	₪ 390
M16X2	SG016QBJPX	₪ 654	5/8-11UNC	SGU10UYJPX	₪ 790

MF	מק"ט	מחיר	UNF	מק"ט	מחיר
DIN 371			DIN 371		
M10X1.25	SM010NBJPX	₪ 359	No.10-32UNF	SDUNAJYJPX	₪ 209
M12X1.5	SM0120BJPX	₪ 465	1/4-28UNF	SDU04KYJPX	₪ 204
M12X1.25	SM012NBJPX	₪ 465	DIN 374		
			5/16-24UNF	SMU05MYJPX	₪ 289
			3/8-24UNF	SMU06MYJPX	₪ 302
			7/16-20UNF	SMU07NYJPX	₪ 372
			1/2-20UNF	SMU08NYJPX	₪ 415
			9/16-18UNF	SMU090YJPX	₪ 577
			5/8-18UNF	SMU100YJPX	₪ 790

M	מק"ט	מחיר	UNC	מק"ט	מחיר
DIN 371			DIN 371		
M3X0.5	PD3.0GBJPW	₪ 218	No.6-32UNC	PDUN6JYJPW	₪ 193
M4X0.7	PD4.0IBJPW	₪ 218	No.8-32UNC	PDUN8JYJPW	₪ 193
M5X0.8	PD5.0KBJPW	₪ 224	No.10-24UNC	PDUNAMYJPW	₪ 188
M6X1	PD6.0MBJPW	₪ 224	1/4-20UNC	PDU04NYJPW	₪ 183
M8X1.25	PD8.0NBJPW	₪ 275	5/16-18UNC	PDU050YJPW	₪ 259
M10X1.5	PD0100BJPW	₪ 326	3/8-16UNC	PDU06PYJPW	₪ 272
DIN 376			DIN 376		
M12X1.75	PG012PBJPW	₪ 429	1/2-13UNC	PGU08RYJPW	₪ 390
M14X2	PG014QBJPW	₪ 541	5/8-11UNC	PGU10UYJPW	₪ 752
M16X2	PG016QBJPW	₪ 685			

MF	מק"ט	מחיר	UNF	מק"ט	מחיר
DIN 374			DIN 371		
M10X1.25	PM010NBJPW	₪ 376	No.10-32UNF	PDUNAJYJPW	₪ 209
M12X1.5	PM0120BJPW	₪ 465	1/4-28UNF	PDU04KYJPW	₪ 204
M12X1.25	PM012NBJPW	₪ 443	DIN 374		
			5/16-24UNF	PMU05MYJPW	₪ 289
			3/8-24UNF	PMU06MYJPW	₪ 306
			1/2-20UNF	PMU08NYJPW	₪ 415
			5/8-18UNF	PMU100YJPW	₪ 790



**HP+RZ/HP-RZ**



ISO	Vc (m/min)	ISO	Vc (m/min)	ISO	Vc (m/min)	ISO	Vc (m/min)
P1	15÷30 ★	P4	15÷25 ★	M1	10÷25 ★	N1	10÷45 ☆
P2	15÷30 ★	P7	10÷25 ★	M2	10÷25 ★	N2	10÷45 ☆
P3	15÷25 ★						

★ 1st choice ☆ suitable

Oversized

M	TCTR (tolerance)	מק"ט	מחיר
JIS			
<b>M1X0.25</b>	G4	HRZP41.0BB	₪ 361
<b>M1.2X0.25</b>	G4	HRZP41.2BB	₪ 308
<b>M1.4X0.3</b>	G4	HRZP41.4CB	₪ 289
<b>M1.6X0.35</b>	G4	HRZP41.6DB	₪ 278

M	TCTR (tolerance)	מק"ט	מחיר
DIN 371			
<b>M2X0.4</b>	ISO2X(6HX)	RE2.0EBFPTB	₪ 345
	ISO3X(6GX)	RE2.0ENFPTB	₪ 345
<b>M2.5X0.45</b>	ISO2X(6HX)	RE2.5FBFPTB	₪ 345
	ISO3X(6GX)	RE2.5FNPTB	₪ 345
<b>M3X0.5</b>	ISO2X(6HX)	RE3.0GBFPTB	₪ 303
	ISO3X(6GX)	RE3.0GNFPTB	₪ 316
<b>M4X0.7</b>	ISO2X(6HX)	RE4.0IBFPTB	₪ 325
	ISO3X(6GX)	RE4.0INFPTB	₪ 340
<b>M5X0.8</b>	ISO2X(6HX)	RE5.0KBFPTB	₪ 349
	ISO3X(6GX)	RE5.0KNFPTB	₪ 365
<b>M6X1</b>	ISO2X(6HX)	RE6.0MBFPTB	₪ 349
	ISO3X(6GX)	RE6.0MNFPTB	₪ 365

M	TCTR (tolerance)	מק"ט	מחיר
DIN 371			
<b>M8X1.25</b>	ISO2X(6HX)	RD8.0NBFPTB	₪ 434
	ISO3X(6GX)	RD8.0NNFPTB	₪ 443
<b>M10X1.5</b>	ISO2X(6HX)	RD0100BFPTB	₪ 494
	ISO3X(6GX)	RD0100NFPTB	₪ 505
DIN 376			
<b>M12X1.75</b>	ISO2X(6HX)	RG012PBFPTB	₪ 633
	ISO3X(6GX)	RG012PNFPTB	₪ 647
<b>M14X2</b>	ISO2X(6HX)	RG014QBFPTB	₪ 882
<b>M16X2</b>	ISO2X(6HX)	RG016QBFPTB	₪ 883

MF	TCTR (tolerance)	מק"ט	מחיר
DIN 374			
<b>M10X1.25</b>	ISO2X(6HX)	RM010NBFPTB	₪ 509
<b>M12X1.5</b>	ISO2X(6HX)	RM0120BFPTB	₪ 627
<b>M12X1.25</b>	ISO2X(6HX)	RM012NBFPTB	₪ 558
<b>M14X1.5</b>	ISO2X(6HX)	RM0140BFPTB	₪ 882
<b>M16X1.5</b>	ISO2X(6HX)	RM0160BFPTB	₪ 916

UNC	TCTR (tolerance)	מק"ט חדש	מק"ט ישן	מחיר
ANSI				
<b>No.2-56UNC</b>	H3	386801M	Y86801	₪ 403
<b>No.3-48UNC</b>	H3	386802M	Y86802	₪ 403
<b>No.4-40UNC</b>	H3	386804M	Y86804	₪ 313
<b>No.5-40UNC</b>	H5	386799M	Y86799	₪ 336
<b>No.6-32UNC</b>	H5	386809M	Y86809	₪ 301
<b>No.8-32UNC</b>	H5	386813M	Y86813	₪ 301
<b>No.10-24UNC</b>	H6	386817M	Y86817	₪ 301
<b>1/4-20UNC</b>	H6	386825M	Y86825	₪ 309
<b>5/16-18UNC</b>	H7	386833M	Y86833	₪ 355
<b>3/8-16UNC</b>	H7	386841M	Y86841	₪ 523

UNF	TCTR (tolerance)	מק"ט חדש	מק"ט ישן	Stock
ANSI				
<b>No.0-80UNF</b>	H2	386800M	Y86800	₪ 336
<b>No.3-56UNF</b>	H3	386803M	Y86803	₪ 403
<b>No.4-48UNF</b>	H5	386807M	Y86807	₪ 368
<b>No.10-32UNF</b>	H6	386821M	Y86821	₪ 301
<b>1/4-28UNF</b>	H6	386829M	Y86829	₪ 309
<b>3/8-24UNF</b>	H7	386845M	Y86845	₪ 523

מברזים לאלומיניום, יציקות, נחושת ופליז - פס ירוק

**AL+SP/AL-SP**



M	מק"ט	מחיר	ISO	Vc (m/min)
DIN 371				
<b>M2X0.4</b>	SE2.0EALEN	₪ 180	N1	10÷25 ★
<b>M2.5X0.45</b>	SE2.5FALEN	₪ 153	N2	10÷25 ★
<b>M3X0.5</b>	SE3.0GALEN	₪ 121	N3	10÷25 ★
<b>M4X0.7</b>	SE4.0IALEN	₪ 121	N4	10÷25 ★
<b>M5X0.8</b>	SE5.0KALEN	₪ 125		
<b>M6X1</b>	SE6.0MALEN	₪ 125		
<b>M8X1.25</b>	SD8.0NALEN	₪ 147		
<b>M10X1.5</b>	SD0100ALEN	₪ 177		
DIN 376				
<b>M12X1.75</b>	SG012PALEN	₪ 251		
<b>M14X2</b>	SG014QALEN	₪ 303		
<b>M16X2</b>	SG016QALEN	₪ 383		

★ 1st choice ☆ suitable

**LA-HT**



M	מק"ט	מחיר	ISO	Vc (m/min)
DIN 371				
<b>M2X0.4</b>	TD2.0EBLEN5	₪ 176	N1	5÷15 ★
<b>M2.5X0.45</b>	TD2.5FBLEN5	₪ 149	N2	5÷15 ★
<b>M3X0.5</b>	TD3.0GBLEN5	₪ 118	N3	5÷10 ★
<b>M4X0.7</b>	TD4.0IBLEN5	₪ 118	N4	5÷10 ★
<b>M5X0.8</b>	TD5.0KBLEN5	₪ 122		
<b>M6X1</b>	TD6.0MBLEN5	₪ 122		
<b>M8X1.25</b>	TD8.0NBLEN5	₪ 153		
<b>M10X1.5</b>	TD0100BLEN5	₪ 185		
DIN 376				
<b>M12X1.75</b>	TG012PBLEN5	₪ 245		
<b>M14X2</b>	TG014QBLEN5	₪ 296		
<b>M16X2</b>	TG016QBLEN5	₪ 374		

★ 1st choice ☆ suitable

**SP**



ISO	Vc (m/min)	ISO	Vc (m/min)	ISO	Vc (m/min)	ISO	Vc (m/min)
P1	5÷10 ☆	P3	5÷10 ☆	N1	5÷10 ☆	N3	5÷10 ☆
P2	5÷10 ★	P4	5÷8 ☆	N2	5÷10 ☆	N4	5÷10 ☆

★ 1st choice ☆ suitable

UNC	מק"ט	מחיר	UNF	מק"ט	מחיר
DIN 371			DIN 371		
No.2-56UNC	*SPPUN2E	157 ₪	No.2-64UNF	*SPPUN2D	157 ₪
No.3-48UNC	*SPPUN3F	132 ₪	No.3-56UNF	*SPPUN3E	132 ₪
No.4-40UNC	SDUN4HXNEB	160 ₪	No.4-48UNF	SDUN4FXNEB	129 ₪
No.5-40UNC	SDUN5HXNEB	129 ₪	No.5-44UNF	SDUN5GXNEB	129 ₪
No.6-32UNC	SDUN6JXNEB	123 ₪	No.6-40UNF	SDUN6HXNEB	136 ₪
No.8-32UNC	SDUN8JXNEB	123 ₪	No.8-36UNF	SDUN8IXNEB	122 ₪
No.10-24UNC	SDUNAMXNEB	120 ₪	No.10-32UNF	SDUNAJXNEB	130 ₪
No.12-24UNC	SDUNCMXNEB	133 ₪	No.12-28UNF	SDUNCCKXNEB	133 ₪
1/4-20UNC	SDU04NXNEB	111 ₪	1/4-28UNF	SDU04KXNEB	125 ₪
5/16-18UNC	SDU05OXNEB	163 ₪	DIN 374		
3/8-16UNC	SDU06PXNEB		5/16-24UNF	SMU05MXNEB	184 ₪
DIN 376			3/8-24UNF	SMU06MXNEB	188 ₪
7/16-14UNC	SGU07QXNEB	210 ₪	7/16-20UNF	SMU07NXNEB	231 ₪
1/2-13UNC	SGU08RXNEB	236 ₪	1/2-20UNF	SMU08NXNEB	260 ₪
9/16-12UNC	SGU09SXNEB	324 ₪	9/16-18UNF	SMU09OXNEB	359 ₪
5/8-11UNC	SGU10UXNEB	328 ₪	5/8-18UNF	SMU100XNEB	361 ₪

\*JIS

**PO**



ISO	Vc (m/min)	ISO	Vc (m/min)	ISO	Vc (m/min)	ISO	Vc (m/min)
P1	5÷10 ☆	P3	5÷10 ☆	N1	5÷10 ☆	N3	5÷10 ☆
P2	5÷10 ★	P4	5÷8 ☆	N2	5÷10 ☆	N4	5÷10 ☆

★ 1st choice ☆ suitable

UNC	מק"ט	מחיר	UNF	מק"ט	מחיר
DIN 371			DIN 371		
No.2-56UNC	*POPUN2E	152 ₪	No.0-80UNF	*POPUN0B	199 ₪
No.3-48UNC	*POPUN3F	127 ₪	No.1-72UNF	*POPUN1C	179 ₪
No.4-40UNC	PDUN4HXNEB	156 ₪	No.2-64UNF	*POPUN2D	138 ₪
No.5-40UNC	PDUN5HXNEB	129 ₪	No.3-56UNF	*POPUN3E	116 ₪
No.6-32UNC	PDUN6JXNEB	120 ₪	No.4-48UNF	PDUN4FXNEB	131 ₪
No.8-32UNC	PDUN8JXNEB	120 ₪	No.5-44UNF	PDUN5GXNEB	142 ₪
No.10-24UNC	PDUNAMXNEB	117 ₪	No.6-40UNF	PDUN6HXNEB	113 ₪
No.12-24UNC	PDUNCMXNEB	115 ₪	No.8-36UNF	PDUN8IXNEB	113 ₪
1/4-20UNC	PDU04NXNEB	108 ₪	No.10-32UNF	PDUNAJXNEB	127 ₪
5/16-18UNC	PDU05OXNEB	154 ₪	No.12-28UNF	PDUNCCKXNEB	115 ₪
3/8-16UNC	PDU06PXNEB	166 ₪	1/4-28UNF	PDU04KXNEB	123 ₪
DIN 376			DIN 374		
7/16-14UNC	PGU07QXNEB	204 ₪	5/16-24UNF	PMU05MXNEB	159 ₪
1/2-13UNC	PGU08RXNEB	230 ₪	3/8-24UNF	PMU06MXNEB	184 ₪
9/16-12UNC	PGU09SXNEB	290 ₪	7/16-20UNF	PMU07NXNEB	226 ₪
5/8-11UNC	PGU10UXNEB	295 ₪	1/2-20UNF	PMU08NXNEB	252 ₪
			9/16-18UNF	PMU09OXNEB	322 ₪
			5/8-18UNF	PMU100XNEB	324 ₪

מברזים ארוכים לשימוש כללי

**LS-SP**



ISO	Vc (m/min)	ISO	Vc (m/min)	ISO	Vc (m/min)	ISO	Vc (m/min)
P1	5÷10 ☆	P3	5÷10 ☆	N1	5÷10 ☆	N3	5÷10 ☆
P2	5÷10 ★	P4	5÷8 ☆	N2	5÷10 ☆	N4	5÷10 ☆

★ 1st choice ☆ suitable

M	מק"ט	אורך כללי	מחיר	M	מק"ט	אורך כללי	מחיר
JIS				JIS			
M3X0.5	SPFP3.0GL10	100	248 ₪	M10X1.5	SPQ0100L15	150	456 ₪
M4X0.7	SPFQ4.0IL10	100	228 ₪		SPQ0100L20	200	700 ₪
	SPFQ4.0IL15	150	425 ₪		SPQ012PL15	150	575 ₪
M5X0.8	SPFQ5.0KL10	100	197 ₪	M12X1.75	SPQ012PL20	200	813 ₪
	SPFQ5.0KL15	150	330 ₪		SPQ014QL15	150	761 ₪
M6X1	SPFQ6.0ML10	100	168 ₪	M16X2	SPQ016QL15	150	780 ₪
	SPFQ6.0ML15	150	292 ₪		SPQ016QL20	200	1014 ₪
M8X1.25	SPQ8.0NL10	100	229 ₪	M20X2.5	SPR020RL20	200	1382 ₪
	SPQ8.0NL15	150	386 ₪	M24X3	SPR024SL20	200	1642 ₪

**LS-PO**



ISO	Vc (m/min)	ISO	Vc (m/min)	ISO	Vc (m/min)	ISO	Vc (m/min)
P1	5÷10 ☆	P3	5÷10 ☆	N1	5÷10 ☆	N3	5÷10 ☆
P2	5÷10 ★	P4	5÷8 ☆	N2	5÷10 ☆	N4	5÷10 ☆

★ 1st choice ☆ suitable

M	מק"ט	אורך כללי	מחיר	M	מק"ט	אורך כללי	מחיר
JIS				JIS			
M3X0.5	POFQ3.0GL10	100	239 ₪	M16X2	POS016QL15	150	751 ₪
M4X0.7	POFQ4.0IL10	100	219 ₪			POS016QL20	200
		POFQ4.0IL15	150	437 ₪	M20X2.5	POS020RL20	200
M5X0.8	POFQ5.0KL10	100	190 ₪				
	POFQ5.0KL15	150	338 ₪				
M6X1	POFQ6.0ML10	100	163 ₪				
	POFQ6.0ML15	150	300 ₪				
M10X1.5	POR0100L15	150	440 ₪				
M12X1.75	POS012PL15	150	553 ₪				



ISO Vc (m/min)

N1	5÷15	★
N2	5÷15	★
N3	5÷15	★

★ 1st choice ☆ suitable

Oversized

M	TCTR (tolerance)	מק"ט	מחיר
DIN 371			
M2X0.4	ISO2X(6HX)	RE2.0EBKENB	274
M2.5X0.45	ISO2X(6HX)	RE2.5FBKENB	238
M3X0.5	ISO2X(6HX)	RE3.0GBKENB	180
M4X0.7	ISO2X(6HX)	RE4.0IBKENB	180
M5X0.8	ISO2X(6HX)	RE5.0KBKENB	188
M6X1	ISO2X(6HX)	RE6.0MBKENB	188
M8X1.25	ISO2X(6HX)	RD8.0NBHEXB	246
M10X1.5	ISO2X(6HX)	RD0100BHEXB	242

UNC	TCTR (tolerance)	מק"ט	מחיר
JIS			
No.2-56UNC	G4	NRSM4UN2EB	142
	G5(G4+13)	NRSM5UN2EB	142
No.3-48UNC	G4	NRSM4UN3FB	127
	G5(G4+13)	NRSM5UN3FB	127
No.4-40UNC	G5	NRSM5UN4HB	123
	G6(G5+13)	NRSM6UN4HB	123
No.6-32UNC	G5	NRSM5UN6JB	111
	G6(G5+13)	NRSM6UN6JB	111
No.8-32UNC	G6	NRSM6UN8JB	121
	G7(G6+13)	NRSM7UN8JB	121
No.10-24UNC	G6	NRSM6UNAMB	129
	G7(G6+13)	NRSM7UNAMB	129
1/4-20UNC	G6	NRSM6U04NB	140
	G8(G7+13)	NRSM8U04NB	140

UNF	TCTR (tolerance)	מק"ט	מחיר
JIS			
No.0-80UNF	G5	NRSM5UN0BB	193
No.1-72UNF	G5	NRSM5UN1CB	184
No.4-48UNF	G5	NRSM5UN4FB	123
	G6(G5+13)	NRSM6UN4FB	123
No.5-44UNF	G6	NRSM6UN5GB	119
No.6-40UNF	G5	NRSM5UN6HB	111
No.8-36UNF	G5	NRSM5UN8IB	121
	G6(G5+13)	NRSM6UN8IB	121
No.10-32UNF	G6	NRSM6UNAJB	129
	G7(G6+13)	NRSM7UNAJB	129
1/4-28UNF	G6	NRSM6U04KB	140



ISO Vc (m/min)

N1	5÷15	★
N2	5÷15	★
N3	5÷15	★

★ 1st choice ☆ suitable

M	מק"ט	THCHT (chamfer)	אורך כללי	מחיר
JIS				
M3X0.5	NRSF53.0GP10	4P	100	242
	NRSF53.0GB10	2P	100	242
M4X0.7	NRSF64.0IP10	4P	100	217
	NRSF64.0IB10	2P	100	217
M5X0.8	NRSF65.0KP10	4P	100	195
	NRSF65.0KB10	2P	100	195
M6X1	NRSF76.0MP10	4P	100	184
	NRSF76.0MP15	4P	150	284
M8X1.25	NRSM78.0NP10	4P	100	223
	NRSM78.0NP15	4P	150	367
M10X1.5	NRSM70100P10	4P	100	221
	NRSM70100P15	4P	150	430

מברזי לחץ הליקויל לאלומיניום



ISO Vc (m/min)

N1	5÷15	★
N2	5÷15	★
N3	5÷15	★

★ 1st choice ☆ suitable

EG(STI) M	מק"ט	אורך כללי	מחיר
JIS			
STI M3X0.5	RW3.0G3LENB	52	187
STI M4X0.7	RW4.0I4LENB	60	181
STI M5X0.8	RW5.0K4LENB	62	175
STI M6X1	RW6.0M4LENB	70	191
STI M8X1.25	RW8.0N4LENB	75	266
STI M10X1.5	RW01005LENB	82	358
STI M12X1.75	RW012P6LENB	95	491



ISO	Vc (m/min)
N1	5÷15 ★
N2	5÷15 ★
N3	5÷10 ☆
N4	5÷10 ★

★ 1st choice ☆ suitable

EG(STI) M	מק"ט	אורך כללי	מחיר
JIS			
STI M3X0.5	TW3.0G1LEBA	52	₪ 124
STI M4X0.7	TW4.0I1LEBA	60	₪ 121
STI M5X0.8	TW5.0K1LEBA	62	₪ 116
STI M6X1	TW6.0M1LEBA	70	₪ 127
STI M8X1.25	TW8.0N1LEBA	75	₪ 177
STI M10X1.5	TW01001LEBA	82	₪ 238
STI M12X1.75	TW012P1LEBA	95	₪ 297
STI M16X2	TW016Q1LEBA	105	₪ 567

EG(STI) UNC	מק"ט	אורך כללי	מחיר
JIS			
STI No.4-40UNC	TWUN4H1LEBA	52	₪ 142
STI No.6-32UNC	TWUN6J1LEBA	60	₪ 133
STI No.8-32UNC	TWUN8J1LEBA	62	₪ 131
STI No.10-24UNC	TWUNAM1LEBA	62	₪ 131
STI 1/4-20UNC	TWU04N1LEBA	70	₪ 178
STI 5/16-18UNC	TWU05O1LEBA	75	₪ 234
STI 3/8-16UNC	TWU06P1LEBA	82	₪ 258
STI 1/2-13UNC	TWU08R1LEBA	95	₪ 424

EG(STI) UNF	מק"ט	אורך כללי	מחיר
JIS			
STI No.10-32UNF	TWUNAJ1LEBA	62	₪ 131
STI 1/4-28UNF	TWU04K1LEBA	70	₪ 178
STI 5/16-24UNF	TWU05M1LEBA	75	₪ 234
STI 3/8-24UNF	TWU06M1LEBA	82	₪ 258
STI 1/2-20UNF	TWU08N1LEBA	95	₪ 424



ISO	Vc (m/min)
N1	10÷25 ★
N2	10÷25 ★
N3	10÷25 ★
N4	10÷25 ★

★ 1st choice ☆ suitable

EG(STI) M	מק"ט	מחיר
JIS		
STI M3X0.5	SW3.0G1LEN	₪ 141
STI M4X0.7	SW4.0I1LEN	₪ 138
STI M5X0.8	SW5.0K1LEN	₪ 132
STI M6X1	SW6.0M1LEN	₪ 144
STI M8X1.25	SW8.0N1LEN	₪ 203
STI M10X1.5	SW01001LEN	₪ 272
STI M12X1.75	SW012P1LEN	₪ 375
STI M16X2	SW016Q1LEN	₪ 670

מברז ספירלי UNEF

**SP**



ISO	Vc (m/min)	ISO	Vc (m/min)
P1	5÷10 ☆	N1	5÷10 ☆
P2	5÷10 ★	N2	5÷10 ☆
P3	5÷10 ☆	N3	5÷10 ☆
P4	5÷8 ☆	N4	5÷10 ☆

★ 1st choice ☆ suitable

UNEF	מק"ט	אורך כללי	מחיר
JIS			
1/4-32UNEF	SPQU04J	62	₪ 141
5/16-32UNEF	SPQU05J	70	₪ 197
3/8-32UNEF	SPQU06J	75	₪ 239
7/16-28UNEF	SPQU07K	82	₪ 307
9/16-24UNEF	SPQU09M	95	₪ 523
5/8-24UNEF	SPQU10M	95	₪ 576
3/4-20UNEF	SPQU12N	105	₪ 882

יש לציין DIN1837 למשורית פלדה או DIN1838 למשורית אלומיניום.

קוטר (קדח)	40 (10)	50 (13)	63 (16)	80 (22)	100 (22)	125 (22)	150 (32)	160 (32)	200 (32)	250 (32)
0.2	נ165	נ252	נ193							
0.25	נ165	נ252	נ185							
0.3	נ165	נ252	נ169	נ492						
0.4	נ165	נ224	נ165	נ464	נ653					
0.45	נ165	נ216	נ169	נ358	נ653					
0.5	נ165	נ216	נ169	נ354	נ653	נ1133				
0.6	נ165	נ228	נ169	נ338	נ629	נ1070				
0.7	נ165	נ248	נ173	נ342	נ598	נ1031	נ1668			
0.8	נ165	נ268	נ181	נ374	נ539	נ916	נ1668	נ1762		
0.9	נ165	נ279	נ189	נ393	נ539	נ916	נ1786	נ1746		
1	נ177	נ287	נ193	נ397	נ507	נ861	נ1656	נ1746		
1.1	נ177	נ295	נ201	נ401	נ527	נ928	נ1750	נ1786		
1.2	נ177	נ307	נ205	נ417	נ559	נ995	נ1849	נ1974		
1.3	נ181	נ307	נ228	נ437	נ590	נ1058	נ1896	נ2077		
1.4	נ189	נ315	נ236	נ452	נ610	נ1125	נ2175	נ2140		
1.5	נ193	נ330	נ244	נ460	נ633	נ1070	נ2238	נ2140	נ3504	
1.6	נ201	נ338	נ248	נ472	נ661	נ1259	נ2254	נ2140		
1.7	נ212	נ354	נ252	נ507	נ696	נ1321	נ2269	נ2238		
1.8	נ216	נ354	נ268	נ515	נ716	נ1392	נ2269	נ2336		
1.9	נ216	נ374	נ268	נ527	נ759	נ1455	נ2368	נ2419		
2	נ224	נ389	נ283	נ551	נ787	נ1522	נ2368	נ2419	נ4971	נ7744
2.5	נ291	נ456	נ342	נ641	נ905	נ1852	נ2560	נ2855	נ6053	נ6938
3	נ326	נ515	נ393	נ759	נ1038	נ2183	נ2820	נ2985	נ7135	נ8169
4	נ401	נ653	נ472	נ912	נ1357	נ2844	נ3697	נ3890	נ9294	נ10599
5	נ480	נ775	נ582	נ1105	נ1668	נ3500	נ4539	נ4798	נ11453	נ13062
6	נ570	נ1007	נ669	נ1286	נ2147	נ4161	נ5380	נ5707	נ13616	נ15559

ניתן לקבל מידות נוספות לפי הצעה.

## Karnasch®

### מחזיק משוריות סגירה קדמית מהמצח

5 6100

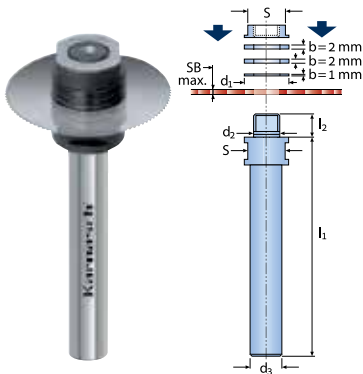

מקט	d2 h6	d3 h6	d1	l1	l2	SB max	S	מחיר
561000506	● 5	6	10	70	10	6	8	נ762
561000510	● 5	10	10	80	10	6	8	נ762
561000810	● 8	10	15	80	10	6	13	נ874
561000812	● 8	12	15	90	11	6	13	נ874
561001006	● 10	6	18	80	10.5	6	15	נ906
561001010	● 10	10	18	80	10.5	6	15	נ906
561001016	● 10	16	18	100	11.5	6	15	נ906
561001316	● 13	16	22	110	12	6	19	נ1017
561001610	● 16	10	22	80	8	3	19	נ1170
561001620	● 16	20	26	120	13	6	22	נ1170
561002216	● 22	16	32	120	13	6	27	נ1170

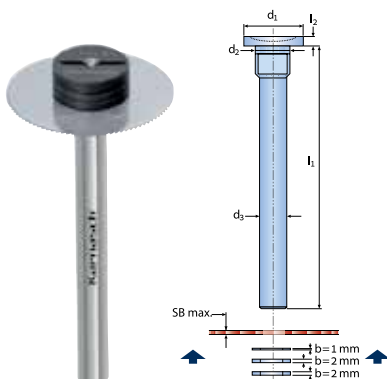

### מחזיק משוריות סגירה אחורית מהקנה

5 6101

מקט	d2 h6	d3 h6	d1	l1	l2	SB max	S	מחיר
561010504	5	4	10	50	2	6	8	נ762
561010806	8	6	15	70	2	6	13	נ874
561011008	10	8	18	90	2.5	6	15	נ906
561011310	13	10	22	110	2.5	6	19	נ1017
561011612	16	12	26	120	2.5	6	22	נ1170



פצירות ה- **NG6** הן הפצירות האגרסיביות בעולם. הגאומטריה והציפוי היחודיים מקנים הסרת חומר מואצת בפלדות ניירווסטה בין 75%-100% ביחס לשובר השבב הסטנדרטי.

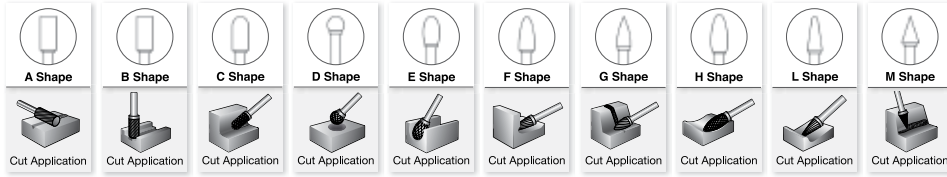

**NG6 A**



מק"ט	קוטר	אורך פעיל	קנה	אורך כללי	מחיר
KA60618-NG6 ACC	6	18	6	50	₪83
KA60820-NG6 ACC	8	19	6	64	₪109
KA61020-NG6 ACC	9.6	19	6	64	₪117
KA61225-NG6 DIN ACC	12	25	6	70	₪183
KA61525-NG6 ACC	16	25	6	70	₪231

**NG6 F**



מק"ט	קוטר	אורך פעיל	קנה	אורך כללי	מחיר
KF60618-NG6 ACC	6	18	6	50	₪101
KF60820-NG6 ACC	8	20	6	65	₪120
KF61020-NG6 ACC	9.6	19	6	64	₪128
KF61225-NG6 DIN ACC	12	25	6	70	₪189
KF61525-NG6 ACC	16	25	6	70	₪261

**NG6 B**



מק"ט	קוטר	אורך פעיל	קנה	אורך כללי	מחיר
KB60618-NG6 ACC	6	18	6	50	₪92
KB60820-NG6 ACC	8	19	6	64	₪120
KB61020-NG6 ACC	9.6	19	6	64	₪129
KB61225-NG6 DIN ACC	12	25	6	70	₪202
KB61525-NG6 ACC	16	25	6	70	₪254

**NG6 G**



מק"ט	קוטר	אורך פעיל	קנה	אורך כללי	מחיר
KG60618-NG6 ACC	6	18	6	50	₪101
KG60820-NG6 ACC	8	19	6	64	₪123
KG61020-NG6 ACC	9.6	19	6	64	₪137
KG61225-NG6 DIN ACC	12	25	6	70	₪186
KG61525-NG6 ACC	16	25	6	70	₪258

**NG6 C**



מק"ט	קוטר	אורך פעיל	קנה	אורך כללי	מחיר
KC60618-NG6 ACC	6	18	6	50	₪97
KC60820-NG6 ACC	8	19	6	64	₪119
KC61020-NG6 ACC	9.6	19	6	64	₪131
KC61225-NG6 DIN ACC	12	25	6	70	₪206
KC61525-NG6 ACC	16	25	6	70	₪259

**NG6 H**



מק"ט	קוטר	אורך פעיל	קנה	אורך כללי	מחיר
KH60614-NG6 ACC	6	14	6	50	₪101
KH60820-NG6 ACC	8	19	6	64	₪134
KH61020-NG6 ACC	10	20	6	65	₪233
KH61232-NG6 DIN ACC	12	30	6	75	₪274
KH61535-NG6 ACC	16	36	6	81	₪379

**NG6 D**



מק"ט	קוטר	אורך פעיל	קנה	אורך כללי	מחיר
KD60606-NG6 ACC	6	4.7	6	50	₪89
KD60808-NG6 ACC	8	7	6	52	₪96
KD61010-NG6 ACC	9.6	8	6	53	₪107
KD61212-NG6 DIN ACC	12	11	6	56	₪145
KD61515-NG6 ACC	16	14	6	59	₪180

**NG6 L**



מק"ט	קוטר	אורך פעיל	קנה	אורך כללי	מחיר
KL60618-NG6 ACC	6	18	6	50	₪104
KL60822-NG6 ACC	8	25	6	70	₪136
KL61020-NG6 ACC	10	20	6	65	₪164
KL61230-NG6 DIN ACC	12	30	6	75	₪200
KL61533-NG6 ACC	16	33	6	78	₪393

**NG6 E**



מק"ט	קוטר	אורך פעיל	קנה	אורך כללי	מחיר
KE60610-NG6 ACC	6	10	6	50	₪109
KE60815-NG6 ACC	8	15	6	60	₪120
KE61015-NG6 ACC	9.6	16	6	61	₪131
KE61220-NG6 DIN ACC	12	21	6	66	₪192
KE61525-NG6 ACC	16	25	6	70	₪266

**NG6 M**



מק"ט	קוטר	אורך פעיל	קנה	אורך כללי	מחיר
KM60618-NG6 ACC	6	18	6	50	₪104
KM60820-NG6 ACC	8	18.5	6	64	₪152
KM61020-NG6 ACC	10	19	6	64	₪164
KM61222-NG6 DIN ACC	12	25	6	70	₪205
KM61525-NG6 ACC	16	29	6	74	₪274

KA



קוטר	אורך פעיל	קנה	אורך כללי	2	3	6	AS
1.5	6	3	38	KA31.506-2		KA31.506-6	
2	11	3	38	KA30211-2		KA30211-6	
2.5	12	3	38	KA32.512-2		KA32.512-6	
3	12	3	38				KA30312-6AS
3	14	3	38	KA30314-2	KA30314-3	KA30314-6	
3	14	3	50 (XL)	KA30314-2-50		KA30314-6-50	
3	14	3	75 (2XL)	KA30314-2-75		KA30314-6-75	
3	14	3	100 (3XL)	KA30314-2-100		KA30314-6-100	
5	12.7	3	38	KA30512-2		KA30512-6	
6.3	4.7	3	37	KA30605-2		KA30605-6	
6.3	12.7	3	45	KA30612-2	KA30612-3	KA30612-6	

שובר שבב מס' 2

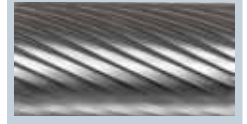

לשימוש כללי בפלדות, נירוסטה, אלומיניום וחומרים קשים.

שובר שבב מס' 3

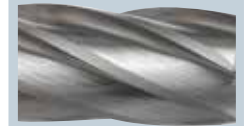

להסרת חומר מהירה בחומרים רכים אלומיניום ופלטיק.

שובר שבב מס' 4



שובר שבב עדין מומלץ לשימוש בפלדות קשות, נירוסטה, ניקל וטיטניום.

שובר שבב מס' 6

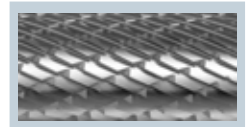

לשימוש כללי בפלדות, נירוסטה, אלומיניום וחומרים קשים.

שובר שבב AS

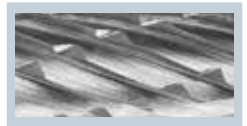

לשימוש בנירוסטה, ניקל וטיטניום.

KC

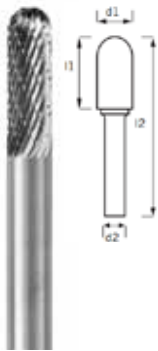

קוטר	אורך פעיל	קנה	אורך כללי	2	3	6	AS
2	11	3	38	KC30211-2		KC30211-6	
2.5	11	3	38	KC32.511-2		KC32.511-6	
3	12	3	38				KC30312-6AS
3	14	3	38	KC30312-2	KC30312-3	KC30312-6	
3	14	3	50 (XL)	KC30312-2-50		KC30312-6-50	
3	14	3	75 (2XL)	KC30312-2-75		KC30312-6-75	
3	14	3	100 (3XL)	KC30312-2-100		KC30312-6-100	
5	12.7	3	38	KC30512-2		KC30512-6	
6	12.7	3	45	KC30612-2	KC30612-3	KC30612-6	

KD

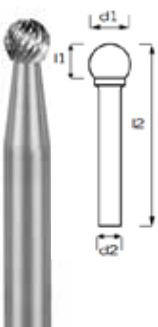

קוטר	אורך פעיל	קנה	אורך כללי	2	3	6	AS
2	1.8	3	38	KD30202-2		KD30202-6	
2.5	2.3	3	38	KD32.52.5-2		KD32.52.5-6	
3	2.5	3	38	KD30303-2	KD30303-3	KD30303-6	KD30303-6AS
3	2.5	3	50 (XL)	KD30303-2-50		KD30303-6-50	
3	2.5	3	75 (2XL)	KD30303-2-75		KD30303-6-75	
4	3.4	3	38	KD30404-2	KD30404-3	KD30404-6	
5	4.7	3	38	KD30505-2		KD30505-6	
6.3	5	3	38	KD30606-2	KD30606-3	KD30606-6	

KE

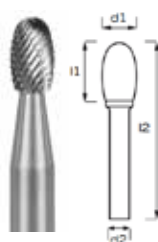

קוטר	אורך פעיל	קנה	אורך כללי	2	3	6	AS
3	6	3	38	KE30306-2	KE30306-3	KE30306-6	KE30306-6AS
3	6	3	50 (XL)	KE30306-2-50		KE30306-6-50	
3	6	3	75 (2XL)	KE30306-2-75		KE30306-6-75	
5	8	3	38	KE30508-2		KE30508-6	
6.3	9.5	3	42	KE30610-2	KE30610-3	KE30610-6	

**KF**

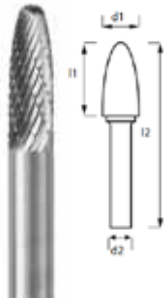

קוטר	אורך פעיל	קנה	אורך כללי	2	3	6	AS
3	6	3	38	KF30306-2		KF30306-6	
3	8	3	38	KF30308-2		KF30308-6	
3	14	3	38	KF30312-2	KF30312-3	KF30312-6	KF30312-6AS
3	14	3	50 (XL)	KF30312-2-50		KF30312-6-50	
3	14	3	75 (2XL)	KF30312-2-75		KF30312-6-75	
5	12.7	3	38	KF30512-2		KF30512-6	
6.3	12.7	3	45	KF30612-2	KF30612-3	KF30612-6	KF30612-6

**KG**

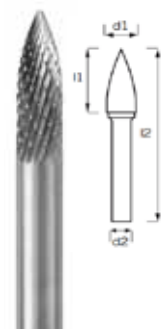

קוטר	אורך פעיל	קנה	אורך כללי	2	3	6	AS
3	6	3	38	KG30306-2		KG30306-6	
3	8	3	38				KG30308-6AS
3	10	3	38	KG30310-2		KG30310-6	
3	14	3	38	KG30312-2	KG30312-3	KG30312-6	KG30314-6AS
3	14	3	50 (XL)	KG30312-2-50		KG30312-6-50	
3	14	3	75 (2XL)	KG30312-2-75		KG30312-6-75	
5	12.7	3	38	KG30512-2		KG30512-6	
6.3	12.7	3	45	KG30612-2	KG30612-3	KG30612-6	

**KH**

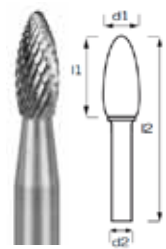

קוטר	אורך פעיל	קנה	אורך כללי	2	3	6	AS
3	6	3	38	KH30306-2		KH30306-6	KH30306-6AS
3	6	3	50 (XL)	KH30306-2-50		KH30306-6-50	
3	6	3	75 (2XL)	KH30306-2-75		KH30306-6-75	
5	9.5	3	38	KH30510-2		KH30510-6	
6	10	3	43	KH30612-2		KH30612-6	

**KL**

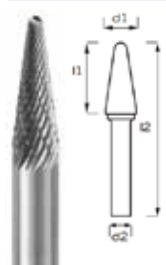

קוטר	אורך פעיל	קנה	אורך כללי	2	3	6	AS
3	10	3	38	KL30310-2		KL30310-6	
3	14	3	38	KL30312-2	KL30312-3	KL30312-6	KL30312-6AS
3	14	3	50 (XL)	KL30312-2-50		KL30312-6-50	
3	14	3	75 (2XL)	KL30312-2-75		KL30312-6-75	
5	12.7	3	38	KL30512-2		KL30512-6	
6.3	15.8	3	48	KL30612-2	KL30612-3	KL30612-6	

**KM**

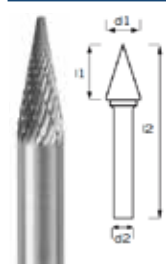

קוטר	אורך פעיל	קנה	אורך כללי	2	3	6	AS
3	8	3	38	KM30308-2		KM30308-6	
3	11	3	38	KM30311-2	KM30311-3	KM30311-6	
3	15	3	38	KM30315-2		KM30315-6	KM30315-6AS
6.3	12.7	3	48	KM30612-2	KM30612-3	KM30612-6	
5	12.7	3	38	KL30512-2		KL30512-6	
6.3	15.8	3	48	KL30612-2	KL30612-3	KL30612-6	

Shape: A, ZYA, SA

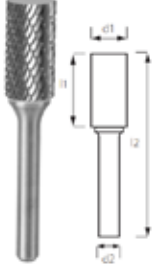

ATA	d1	l1	d2	l2	מחיר
KA30314-6	3	14	3	38	₪32
KA30612-6	6.3	12	3	45	₪52
KA60618-6	6	18	6	50	₪54
KA60820-6	8	19	6	64	₪71
KA61020-6	9.6	19	6	64	₪76
KA61225-6	12	25	6	70	₪119
KA61525-6	16	25	6	70	₪150
KA62025-6	19	25	6	70	₪223

\*ניתן לקבל עם מצח פעיל בתוספת 15%.

Shape: C, WRC, SC



ATA	d1	l1	d2	l2	מחיר
KC30312-6	3	14	3	38	₪32
KC30612-6	6.3	12	3	45	₪52
KC60413-6	4	14	6	50	₪63
KC60516-6	5	16	6	50	₪63
KC60625-6	6	25	6	50	₪63
KC60820-6	8	20	6	64	₪77
KC61020-6	10	20	6	64	₪85
KC61225-6	12	25	6	70	₪133
KC61525-6	16	25	6	70	₪168

Shape: F, RBF, SF

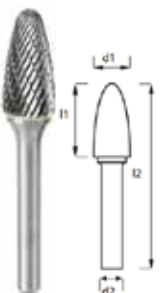

ATA	d1	l1	d2	l2	מחיר
KF30308-6	3	8	3	38	₪32
KF30312-6	3	12	3	38	₪32
KF30612-6	6.3	12	3	45	₪52
KF60618-6	6	18	6	50	₪66
KF60820-6	8	20	6	65	₪77
KF61020-6	10	20	6	64	₪83
KF61220-6	12	20	6	64	₪122
KF61225-6	12	25	6	70	₪123
KF61525-6	16	25	6	70	₪170

Shape: G, SPG, SG



ATA	d1	l1	d2	l2	מחיר
KG30310-6	3	10	3	38	₪32
KG30312-6	3	12	3	38	₪32
KG30612-6	6.3	12	3	45	₪52
KG60618-6	6	18	6	50	₪66
KG60820-6	8	20	6	64	₪80
KG61020-6	10	20	6	64	₪89
KG61225-6	12	25	6	70	₪121

Shape: M, SKM, SM

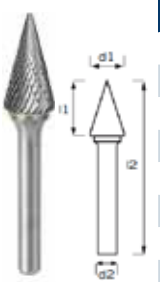

ATA	d1	l1	d2	l2	זווית	מחיר
KM30308-6	3	8	3	38	18	₪32
KM30311-6	3	11	3	38	14	₪32
KM30315-6	3	15	3	38	10	₪32
KM30612-6	6	12	3	49	22	₪52
KM60612-6	6	12	6	50	20	₪64
KM60620-6	6	20	6	50	14	₪67
KM60625-6	6	25	6	50	10	₪73
KM60818-6	8	18	6	64	22	₪98
KM61020-6	10	20	6	64	28	₪106
KM61222-6	12	22	6	71	28	₪133

Shape: E, TRE, SE



ATA	d1	l1	d2	l2	מחיר
KE30306-6	3	6	3	38	₪32
KE30610-6	6.3	9.5	3	42	₪52
KE60610-6	6	10	6	50	₪71
KE60815-6	8	15	6	60	₪78
KE61015-6	10	16	6	60	₪85
KE61220-6	12	22	6	67	₪125
KE61525-6	16	25	6	70	₪173

Shape: D, KUD, SD



ATA	d1	l1	d2	l2	מחיר
KD30303-6	3	2.5	3	38	₪32
KD30606-6	6.3	5	3	38	₪52
KD60606-6	6	4.7	6	50	₪58
KD60808-6	8	6	6	52	₪62
KD61010-6	10	8	6	54	₪70

Shape: H, SH

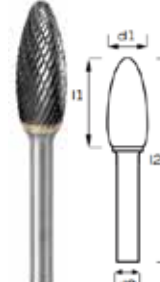

ATA	d1	l1	d2	l2	מחיר
KH30306-6	3	6	3	38	₪32
KH30510-6	5	10	3	38	₪76
KH60614-6	6	14	6	50	₪66
KH60820-6	8	19	6	64	₪87
KH61020-6	10	19	6	65	₪151
KH61232-6	12	32	6	77	₪178

Shape: L, KEL SL

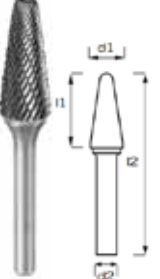

ATA	d1	l1	d2	l2	זווית	מחיר
KL30310-6	3	10	3	38	10	₪32
KL30312-6	3	12	3	38	8	₪32
KL60618-6	6	18	6	50	14	₪67
KL60822-6	8	22	6	70	14	₪88
KL61026-6	10	26	6	76	14	₪106
KL61225-6	12	25	6	70	17	₪131

Rim Shape



ATA	d1	l1	d2	l2	Type	מחיר
KA3101.6-2	10	1.6	3	34	A	₪130
KA6122.6-2	12	2.6	6	48	A	₪130
KRAR62503-2	25	3.2	6	48	RAR	₪410
KRA62505-2	25	5.5	6	50	RAR	₪410
KR62506-2	25	6.3	6	51	A	₪360
KRAR63806-2	38	6.1	6	51	RAR	₪645

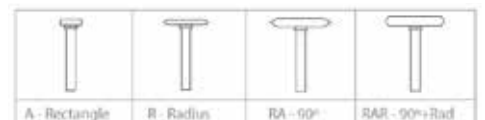



פצירות לאלומיניום

ATA	d1	l1	d2	l2	מחיר
KA60618-3	6	18	6	50	₪68
KA61020-3	10	19	6	64	₪95
KA61225-3	12.7	25	6	70	₪149
KA61525-3	16	25	6	70	₪189
KA62025-3	19	25	6	70	₪280

ATA	d1	l1	d2	l2	מחיר
KC60618-3	6	18	6	50	₪79
KC61020-3	9.6	19	6	64	₪107
KC61225-3	12.7	25	6	70	₪167
KC61525-3	16	25	6	70	₪211
KC62025-3	19	25	6	70	₪302

ATA	d1	l1	d2	l2	מחיר
KD60606-3	6	4.7	6	50	₪73
KD61010-3	9.6	8	6	54	₪87
KD61212-3	12.7	11	6	56	₪118
KD61515-3	16	14	6	59	₪146
KD62020-3	19	16.5	6	62	₪202

ATA	d1	l1	d2	l2	מחיר
KE60610-3	6	10	6	50	₪89
KE61015-3	9.6	16	6	60	₪107
KE61220-3	12.7	22	6	67	₪156
KE61525-3	16	25	6	70	₪217
KE62025-3	19	25	6	70	₪291

ATA	d1	l1	d2	l2	מחיר
KF60618-3	6	18	6	50	₪83
KF61020-3	9.6	19	6	64	₪105
KF61225-3	12.7	25	6	70	₪155
KF61525-3	16	25	6	70	₪213
KF62025-3	19	25	6	70	₪280

ATA	d1	l1	d2	l2	מחיר
KL60618-3	6	18	6	50	₪85
KL61020-3	9.6	30	6	64	₪133
KL61228-3	12.7	25	6	70	₪163
KL61533-3	16	25	6	70	₪321

פצירות ארוכות

ATA	d1	l1	d2	l2	מחיר
KA30314-6-50	3	14	3	50	₪41
KA30314-6-75	3	14	3	75	₪52
KA30314-6-100	3	14	3	100	₪83
KA60618-6-100	6	18	6	100	₪144
KA60618-6-150	6	18	6	150	₪222
KA60820-6-170	8	19	6	170	₪123
KA61020-6-170	10	19	6	170	₪149
KA61225-6-175	12	25	6	170	₪211

ATA	d1	l1	d2	l2	מחיר
KC30312-6-50	3	14	3	50	₪47
KC30312-6-75	3	14	3	75	₪52
KC30312-6-100	3	14	3	100	₪83
KC60618-6-100	6	18	6	100	₪150
KC60618-6-150	6	18	6	150	₪227
KC60820-6-170	8	19	6	170	₪134
KC61020-6-170	10	19	6	170	₪140
KC61225-6-175	12	25	6	170	₪199

ATA	d1	l1	d2	l2	מחיר
KD30303-6-50	3	2.5	3	50	₪43
KD30303-6-75	3	2.5	3	75	₪49
KD60808-180	8	6	6	180	₪119
KD61010-185	10	6	6	185	₪121
KD61212-6-162	12	6	6	162	₪148

ATA	d1	l1	d2	l2	מחיר
KE30306-6-50	3	6	3	50	₪42
KE30306-6-75	3	6	3	75	₪51
KE61015-6-165	9.6	16	6	165	₪141
KE61220-6-170	12.7	22	6	170	₪175

ATA	d1	l1	d2	l2	מחיר
KF30312-6-50	3	14	3	50	₪47
KF30312-6-75	3	14	3	75	₪52
KF60618-6-150	6	18	6	150	₪227
KF61020-6-170	9.6	19	6	170	₪135
KF61225-6-175	12.7	25	6	178	₪175

ATA	d1	l1	d2	l2	מחיר
KG30312-6-50	3	14	3	50	₪42
KG30312-6-75	3	14	3	75	₪51
KG61020-6-170	9.6	19	6	170	₪141
KG61225-6-175	12.7	25	6	175	₪175

ATA	d1	l1	d2	l2	מחיר
KH30306-6-50	3	14	3	50	₪42
KH30306-6-75	3	14	3	75	₪51
KH60820-6-170	8	19	6	170	₪134
KH61232-6-182	12.7	32	6	182	₪225

ATA	d1	l1	d2	l2	מחיר
KL30312-6-50	3	14	3	50	₪42
KL30312-6-75	3	14	3	75	₪51
KL61026-6-176	9.6	30	6	176	₪172
KL61228-6-182	12.7	30	6	182	₪193



קליבר דיגיטלי 111

מק"ט	טווח	רזולוציה	מחיר
111-006-12	0-150	0.01	₪299
111-008-12	0-200	0.01	₪469
111-012-12	0-300	0.01	₪759



מיקרומטר דיגיטלי IP65

מק"ט	טווח	דיוק-מ"מ	מחיר
313-001-01	0-25	0.002	₪810
313-002-01	25-50	0.002	₪998
313-003-01*	50-75	0.003	₪1206



קליבר דיגיטלי IP67

מק"ט	טווח	רזולוציה	מחיר
112-006-12	0-150	0.01	₪994
112-008-12	0-200	0.01	₪1350
112-012-12	0-300	0.01	₪1900



מיקרומטר להבים

מק"ט	טווח	דיוק-מ"מ	מחיר
326-001-03	0-25	0.004	₪1323
326-002-03	25-50	0.004	₪1437
326-003-03	50-75	0.005	₪1576



קליבר עומק דיגיטלי

מק"ט	טווח	רזולוציה	מחיר
171-006-11	0-150	0.01	₪508
171-008-11	0-200	0.01	₪592
171-012-11	0-300	0.01	₪1286



פסומטר

מק"ט	טווח	דיוק-מ"מ	מחיר
349-001-01	0-25	0.003	₪2617
349-002-01*	25-50	0.003	₪2981
349-003-01*	50-75	0.004	₪3848



מיקרומטר פנימי 3 נקודות מדידה

מק"ט	טווח	דיוק-מ"מ	מחיר
362-003-01	10-12	0.004	₪2044
362-004-01	12-16	0.004	₪1556
362-005-01	16-20	0.004	₪1556
362-006-01	20-25	0.004	₪2164



אינדיקטור למדידת מרכז

מק"ט	טווח-מ"מ	מחיר
297-003-11	0.01	₪1297

**מוצא פינה אלקטרוני (תאורה וצפוף)**

692-010-03

₪ 869

**מתקן איפוס אלקטרוני IP65 בסיס מגנטי וכיבוי אוטומטי**

697-050-01

₪ 1164

**פופיטסט דיוק 13 טווח 0-4**

Ø30 - 261-008-11  
Ø37.5 - 261-008-12

₪ 439

**בסיס מגנטי מפרקי 80KG**

283-080-01

₪ 332



M	מיד טבעת נקבה		מיד זכר
	GO	NO-GO	
M2*0.4	533-002-01	532-002-01	532-002-01
M2.2*0.45	533-002-21	532-002-21	532-002-21
M2.5*0.45	533-002-51	532-002-51	532-002-51
M2.6*0.45	533-002-61	532-002-61	532-002-61
M3*0.5	533-003-01	532-003-01	532-003-01
M3.5*0.6	533-003-51	532-003-51	532-003-51
M4*0.7	533-004-01	532-004-01	532-004-01
M5*0.8	533-005-01	532-005-01	532-005-01
M6*1	533-006-01	532-006-01	532-006-01
M7*1	533-007-01	532-007-01	532-007-01
M8*1.25	533-008-01	532-008-01	532-008-01
M9*1.25	533-009-01	532-009-01	532-009-01
M10*1.5	533-010-01	532-010-01	532-010-01
M11*1.5	533-011-01	532-011-01	532-011-01
M12*1.75	533-012-01	532-012-01	532-012-01
M14*2	533-014-01	532-014-01	532-014-01
M16*2	533-016-01	532-016-01	532-016-01
M18*2.5	533-018-01	532-018-01	532-018-01
M20*2.5	533-020-01	532-020-01	532-020-01
M22*2.5	533-022-01	532-022-01	532-022-01
M24*3	533-024-01	532-024-01	532-024-01
M27*3	533-027-01	532-027-01	532-027-01
M30*3.5	533-030-01	532-030-01	532-030-01
M33*3.5	533-033-01	532-033-01	532-033-01
M36*4	533-036-01	532-036-01	532-036-01
M39*4	533-039-01	532-039-01	532-039-01
M42*4.5	533-042-01	532-042-01	532-042-01
M45*4.5	533-045-01	532-045-01	532-045-01
M48*5	533-048-01	532-048-01	532-048-01
M52*5	533-052-01	532-052-01	532-052-01
M56*5.5	533-056-01	532-056-01	532-056-01
M60*5.5	533-060-01	532-060-01	532-060-01

UNC	מיד טבעת נקבה		מיד זכר
	נקבה GO	נקבה NO-GO	
4-40UNC	537-00440-UNC	538-00440-UNC	547-00440-UNC
6-32UNC	537-00632-UNC	538-00632-UNC	547-00632-UNC
8-32UNC	537-00832-UNC	538-00832-UNC	547-00832-UNC
10-24UNC	537-01024-UNC	538-01024-UNC	547-01024-UNC
1/4-20UNC	537-01420-UNC	538-01420-UNC	547-01420-UNC
5/16-18UNC	537-51618-UNC	538-51618-UNC	547-51618-UNC
3/8-16UNC	537-03816-UNC	538-03816-UNC	547-03816-UNC
7/16-14UNC	537-71614-UNC	538-71614-UNC	547-71614-UNC
1/2-13 UNC	537-01213-UNC	538-01213-UNC	547-01213-UNC
9/16-12UNC	537-91612-UNC	538-91612-UNC	547-91612-UNC
5/8-11UNC	537-05811-UNC	538-05811-UNC	547-05811-UNC
3/4-10UNC	537-03410-UNC	538-03410-UNC	547-03410-UNC
7/8-9UNC	537-07809-UNC	538-07809-UNC	547-07809-UNC
1-8 UNC	537-01080-UNC	538-01080-UNC	547-01080-UNC

UNF	מיד טבעת נקבה		מיד זכר
	נקבה GO	נקבה NO-GO	
4-48UNF	537-04048-UNF	538-04048-UNF	547-04048-UNF
6-40UNF	537-06040-UNF	538-06040-UNF	547-06040-UNF
8-36UNF	537-08036-UNF	538-08036-UNF	547-08036-UNF
10-32UNF	537-01032-UNF	538-01032-UNF	547-01032-UNF
1/4-28UNF	537-01428-UNF	538-01428-UNF	547-01428-UNF
5/16-24UNF	537-51624-UNF	538-51624-UNF	547-51624-UNF
3/8-24UNF	537-03824-UNF	538-03824-UNF	547-03824-UNF
7/16-20 UNF	537-71620-UNF	538-71620-UNF	547-71620-UNF
1/2-20 UNF	537-01220-UNF	538-01220-UNF	547-01220-UNF
9/16-18UNF	537-91618-UNF	538-91618-UNF	547-91618-UNF
5/8-18UNF	537-05818-UNF	538-05818-UNF	547-05818-UNF
3/4-16UNF	537-03416-UNF	538-03416-UNF	547-03416-UNF
7/8-14UNF	537-07814-UNF	538-07814-UNF	547-07814-UNF
1-12UNF	537-01012-UNF	538-01012-UNF	547-01012-UNF

BSP / G	מיד טבעת נקבה		מיד זכר
	GO	NO-GO	
G1/8"-28	535-0125-01	536-0125-01	545-0125-01
G1/4"-19	535-0250-01	536-0250-01	545-0250-01
G3/8"-19	535-0375-01	536-0375-01	545-0375-01
G1/2"-14	535-0500-01	536-0500-01	545-0500-01
G5/8"-14	535-0625-01	536-0625-01	545-0625-01
G3/4"-14	535-0750-01	536-0750-01	545-0750-01
G7/8"-14	535-0875-01	536-0875-01	545-0875-01
G1"-11	535-1000-01	536-1000-01	545-1000-01
G1-1/8"-11	535-1125-01	536-1125-01	545-1125-01
G1-1/4"-11	535-1250-01	536-1250-01	545-1250-01
G1-1/2"-11	535-1500-01	536-1500-01	545-1500-01
G1-3/4"-11	535-1750-01	536-1750-01	545-1750-01
G2"-11	535-2000-01	536-2000-01	545-2000-01
G2-1/2"-11	535-2500-01	536-2500-01	545-2500-01
G3"-11	535-3000-01	536-3000-01	545-3000-01

NPT	מיד זכר	מיד נקבה
NPT1/16"X27	544-027-04	544-027-04R
NPT1/8" x 27	544-027-03	544-027-03R
NPT1/4" x 18	544-018-02	544-018-02R
NPT3/8"x18	544-018-33	544-018-33R
NPT1/2" x 14	544-014-01	544-014-01R
NPT3/4"x14	544-014-32	544-014-32R
NPT1"x11.5	544-11D5-10	544-11D5-10R
NPT1-1/4"x11.5	544-11D5-12	544-11D5-12R
NPT1-1/2"x11.5	544-11D5-11	544-11D5-11R
NPT2"x11.5	544-11D5-20	544-11D5-20R
NPT2- 1/2"x8	544-008-21	544-008-21R
NPT3"x8	544-008-30	544-008-30R
NPT3-1/2"x8	544-008-32	544-008-32R
NPT4"x8	544-008-40	544-008-40R

מקדחי קובלט מצופי TiN לשימוש במקדחות מגנטיות באמצעות מתאם

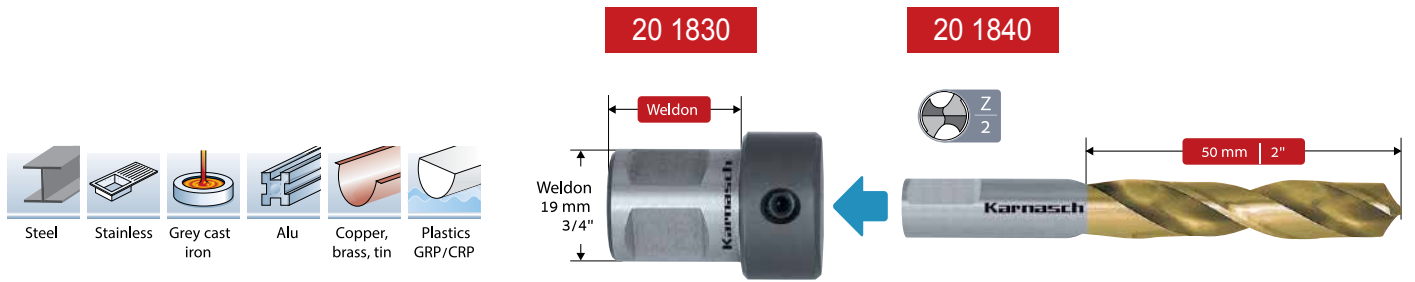

מק"ט מתאם			מק"ט מקדח	תואם למבר
20 1830 002 90		2,5 mm	 Ø 2,5 mm Ø 3/32"	20 1840 002 87 M 3
20 1830 004 90		3 mm	 Ø 3,4 mm Ø 9/64"	20 1840 004 87 M 4
20 1830 010 90		4 mm	 Ø 4,3 mm Ø 11/64"	20 1840 006 87 M 5
			 Ø 4 mm Ø 5/32"	20 1840 010 79 -
20 1830 020 90		5 mm	 Ø 5 mm Ø 13/64"	20 1840 020 88 M 6
20 1830 030 90		6 mm	 Ø 6 mm Ø 15/64"	20 1840 030 103 -
			 Ø 6,8 mm Ø 17/64"	20 1840 035 129 M 8
20 1830 040 90		7 mm	 Ø 7 mm Ø 9/32"	20 1840 040 118 -
20 1830 050 90		8 mm	 Ø 8 mm Ø 5/16"	20 1840 050 138 -
			 Ø 8,5 mm Ø 21/64"	20 1840 055 152 M 10
20 1830 060 90		9 mm	 Ø 9 mm Ø 23/64"	20 1840 060 155 -
20 1830 070 90		10 mm	 Ø 10 mm Ø 25/64"	20 1840 070 169 -
			 Ø 10,3 mm Ø 13/32"	20 1840 075 187 M 12
20 1830 080 90		11 mm	 Ø 11 mm Ø 7/16"	20 1840 080 187 -
20 1830 090 90		12 mm	 Ø 12 mm Ø 15/32"	20 1840 090 205 M 14



**כוסות קידוח MINI-CUT לקידוחים קטנים במגוון חומרים לשימוש במקדחות עמוד ובמקדחות ידניות**

21 1000

MINI-CUT

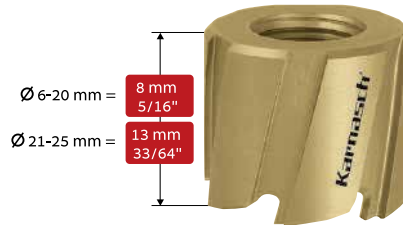
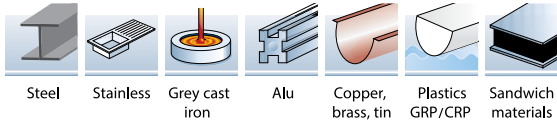

מקט	קוטר	מחיר
21 1000 006	● 6	₪97
21 1000 007	● 7	₪99
21 1000 008	● 8	₪102
21 1000 009	● 9	₪112
21 1000 010	● 10	₪114
21 1000 011	● 11	₪126

מקט	קוטר	מחיר
21 1000 012	● 12	₪128
21 1000 013	● 13	₪137
21 1000 014	● 14	₪139
21 1000 015	● 15	₪149
21 1000 016	● 16	₪151
21 1000 017	● 17	₪163

מקט	קוטר	מחיר
21 1000 018	● 18	₪165
21 1000 019	● 19	₪173
21 1000 020	● 20	₪176
21 1000 021	● 21	₪210
21 1000 022	● 22	₪212
21 1000 023	● 23	₪225

מקט	קוטר	מחיר
21 1000 024	● 24	₪227
21 1000 025	● 25	₪234

21 0002

₪152

Ø 6-20 mm מוביל לקוטר

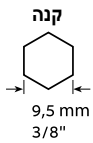

21 0003

₪306

Ø 21-25 mm מוביל לקוטר

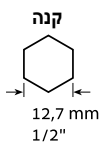

21 2000

₪3515



**סט MINI-CUT**

20 יחידות (מידה במ"מ)

6, 7, 8, 9, 10, 11, 12, 13, 14, 15, 16, 17, 18, 19, 20, 21, 22, 23, 24, 25

x1 פין תואם לקטרים Ø 6-20 mm

x1 פין תואם לקטרים Ø 21-25 mm

x1 מוביל 21 0002

x1 מוביל 21 0003

x1 מפתח אלן

x1 מדגש

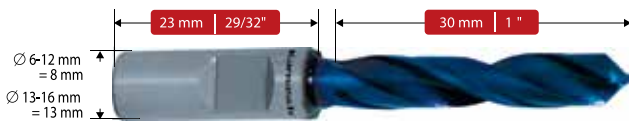
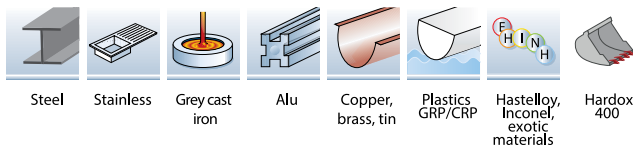

**DRILL-LINE 30 PRO**

מקט	קוטר	מחיר
20 1430 006	• 6	₪258
20 1430 008	• 8	₪258
20 1430 010	• 10	₪313
20 1430 011	• 11	₪352
20 1430 012	• 12	₪391
20 1430 013	• 13	₪481
20 1430 014	• 14	₪571
20 1430 015	• 15	₪595
20 1430 016	• 16	₪677

**מקדח מסונתר עומק קידוח 30 מ"מ**

- כל מקדח מגיע עם פין ויסות קירור  
 - לקטרים 6-12 נדרש מתאם 201431  
 - לקטרים 13-16 נדרש מתאם 201434

**DRILL-LINE 40 PRO**

מקט	קוטר	מחיר
20 1430 017	• 17	₪689
20 1430 018	• 18	₪699
20 1430 019	• 19	₪739
20 1430 020	• 20	₪767
20 1430 021	• 21	₪787
20 1430 022	• 22	₪809
20 1430 023	• 23	₪874
20 1430 024	• 24	₪896
20 1430 0275	• 27.5	₪956

**מקדח מסונתר עם תעלות קירור עומק קידוח 40 מ"מ**

- קנה 19 מ"מ חיבור ישיר למקדחה המגנטית  
 - יש להזמין פין ויסות קירור בנפרד: 201435

**DRILL-LINE 50 PRO**

מקט	קוטר	מחיר	מקט	קוטר	מחיר
20 1465 014	• 14	₪875	20 1465 023	• 23	₪1062
20 1465 015	• 15	₪875	20 1465 024	• 24	₪1183
20 1465 016	• 16	₪908	20 1465 025	• 25	₪1183
20 1465 017	• 17	₪908	20 1465 026	• 26	₪1339
20 1465 018	• 18	₪908	20 1465 027	• 27	₪1339
20 1465 019	• 19	₪908	20 1465 028	• 28	₪1552
20 1465 020	• 20	₪976	20 1465 030	• 30	₪1723
20 1465 021	• 21	₪976	20 1465 032	• 32	₪1860
20 1465 022	• 22	₪1054			

**מקדח מסונתר עם תעלות קירור עומק קידוח 50 מ"מ**

- קנה 19 מ"מ חיבור ישיר למקדחה המגנטית.  
 - יש להזמין פין ויסות קירור בנפרד: 201435.

**20 1195**

**שקען למקדחה מגנטית DURABLUE**

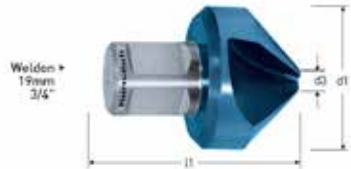

מקט	d1	d3	l1	מחיר
20 1195 025	25	4	45	₪318
20 1195 030	30	4	47	₪376
20 1195 040	40	7	52	₪638
20 1195 055	55	9	60	₪991

**20 1795**

**שקען קנה מורס DURABLUE**



מקט	d1	d3	l1	מורס	מחיר
20 1795 050	40	10	140	MT3	₪824
20 1795 060	50	14	150	MT3	₪1099
20 1795 070	63	16	180	MT4	₪1831
20 1795 080	80	22	190	MT4	₪3114

**מקדחים מדורגים DURABLUE**

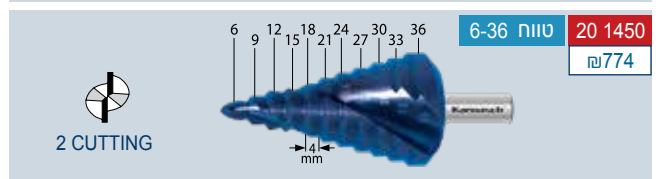
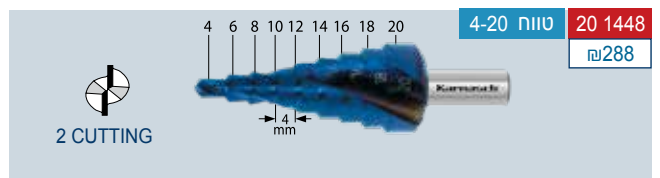
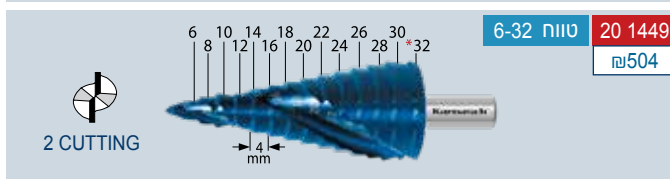
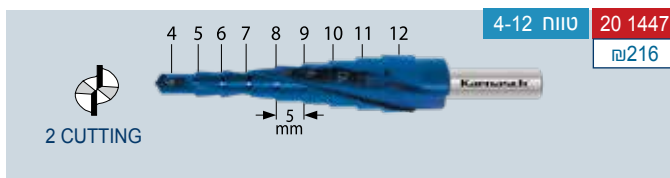

20 1710

DRILL-LINE 30

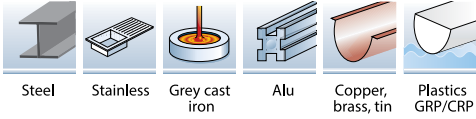

< 900 N < 900 N

<10% Si

מקט	קוטר	מחיר
201710006	• 6	₪161
201710008	• 8	₪161
201710010	• 10	₪161
201710011	• 11	₪188
201710012	• 12	₪188
201710013	• 13	₪232
201710014	• 14	₪232
201710015	• 15	₪276
201710016	• 16	₪276

מקדח מסונתר קנה 3/4 לעומק 30 מ"מ

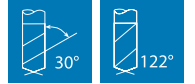
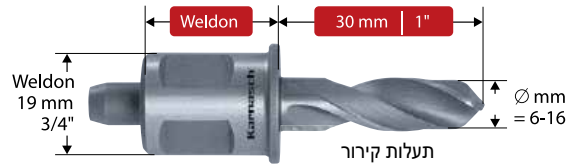

מקדחים בקטרים קטנים לחיבור מהיר וישיר  
למקדחה המגנטית

20 1860

מקדח מתק"ש לחילוץ מברז שבור

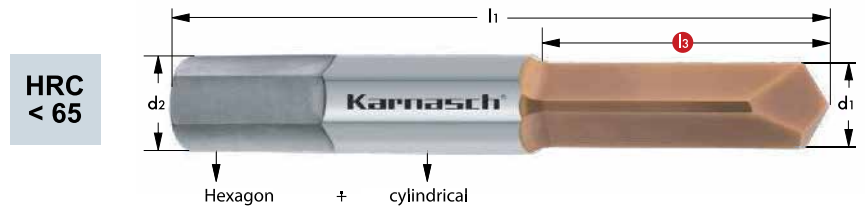

מקט	עבור מברז	d1	L3	L1	d2	מחיר
201860010	• M3	2.5	10	38	3	₪218
201860020	• M4	3.3	14	46	4	₪238
201860030	• M5	4.2	19	50	5	₪285
201860040	• M6	5	23	50	6	₪334
201860050	• M8	6.8	23	60	8	₪431
201860060	• M10	8.5	25	80	10	₪572
201860070	• M12	10.2	35	80	12	₪855

- מיועד לעבודה במכונה סטטית במהירות איטית כאשר החלק מקובע.  
- לא מיועד לשימוש במקדחות ידניות.

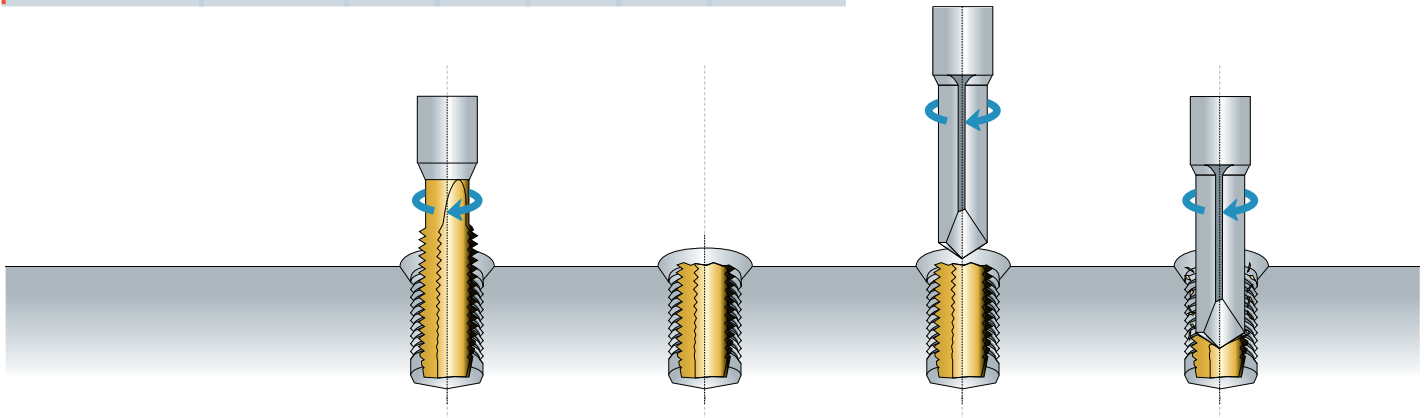

20 1260U

GOLD-DRILLLINE 30

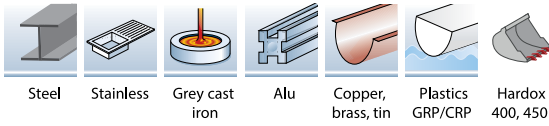

מקט	קוטר	מחיר
20 1260u 012	● 12	₪136
20 1260u 013	● 13	₪136
20 1260u 0135	● 13.5	₪139
20 1260u 014	● 14	₪140
20 1260u 015	● 15	₪140
20 1260u 0155	● 15.5	₪148
20 1260u 016	● 16	₪151
20 1260u 017	● 17	₪151
20 1260u 0175	● 17.5	₪154
20 1260u 018	● 18	₪158
20 1260u 019	● 19	₪158
20 1260u 0195	● 19.5	₪162
20 1260u 020	● 20	₪170
20 1260u 021	● 21	₪170

מקט	קוטר	מחיר
20 1260u 022	● 22	₪201
20 1260u 023	● 23	₪201
20 1260u 024	● 24	₪209
20 1260u 025	● 25	₪209
20 1260u 026	● 26	₪221
20 1260u 0265	● 26.5	₪221
20 1260u 027	● 27	₪221
20 1260u 028	● 28	₪246
20 1260u 029	● 29	₪246
20 1260u 030	● 30	₪258
20 1260u 031	● 31	₪258
20 1260u 032	● 32	₪269
20 1260u 033	● 33	₪269
20 1260u 034	● 34	₪284

מקט	קוטר	מחיר
20 1260u 035	● 35	₪284
20 1260u 036	● 36	₪322
20 1260u 037	● 37	₪334
20 1260u 038	● 38	₪359
20 1260u 039	● 39	₪359
20 1260u 040	● 40	₪394
20 1260u 041	● 41	₪394
20 1260u 042	● 42	₪425
20 1260u 043	● 43	₪425
20 1260u 044	● 44	₪467
20 1260u 045	● 45	₪467
20 1260u 046	● 46	₪502
20 1260u 047	● 47	₪502
20 1260u 048	● 48	₪529

מקט	קוטר	מחיר
20 1260u 049	● 49	₪529
20 1260u 050	● 50	₪565
20 1260u 051	● 51	₪565
20 1260u 052	● 52	₪614
20 1260u 053	● 53	₪633
20 1260u 054	● 54	₪652
20 1260u 055	● 55	₪669
20 1260u 056	● 56	₪693
20 1260u 057	● 57	₪717
20 1260u 058	● 58	₪735
20 1260u 059	● 59	₪758
20 1260u 060	● 60	₪781

מקדח חלול HSS-XE לעומק 30 מ"מ

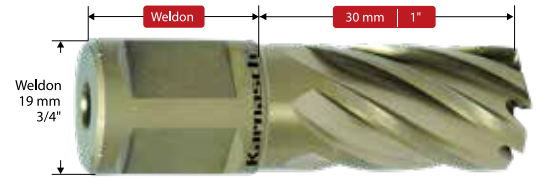

20 1270U

GOLD-DRILLLINE 55

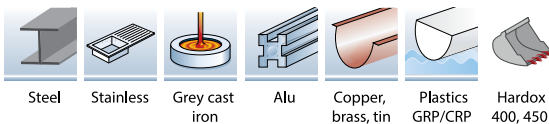

מקט	קוטר	מחיר
20 1270u 012	● 12	₪172
20 1270u 013	● 13	₪172
20 1270u 0135	● 13.5	₪175
20 1270u 014	● 14	₪178
20 1270u 015	● 15	₪178
20 1270u 0155	● 15.5	₪187
20 1270u 016	● 16	₪190
20 1270u 017	● 17	₪190
20 1270u 0175	● 17.5	₪193
20 1270u 018	● 18	₪197
20 1270u 019	● 19	₪197
20 1270u 0195	● 19.5	₪201
20 1270u 020	● 20	₪210
20 1270u 021	● 21	₪210

מקט	קוטר	מחיר
20 1270u 022	● 22	₪238
20 1270u 023	● 23	₪238
20 1270u 024	● 24	₪252
20 1270u 025	● 25	₪252
20 1270u 026	● 26	₪274
20 1270u 0265	● 26.5	₪274
20 1270u 027	● 27	₪274
20 1270u 028	● 28	₪299
20 1270u 029	● 29	₪299
20 1270u 030	● 30	₪314
20 1270u 031	● 31	₪314
20 1270u 032	● 32	₪336
20 1270u 033	● 33	₪336
20 1270u 034	● 34	₪358

מקט	קוטר	מחיר
20 1270u 035	● 35	₪358
20 1270u 036	● 36	₪405
20 1270u 037	● 37	₪421
20 1270u 038	● 38	₪447
20 1270u 039	● 39	₪447
20 1270u 040	● 40	₪489
20 1270u 041	● 41	₪489
20 1270u 042	● 42	₪529
20 1270u 043	● 43	₪529
20 1270u 044	● 44	₪581
20 1270u 045	● 45	₪581
20 1270u 046	● 46	₪625
20 1270u 047	● 47	₪625
20 1270u 048	● 48	₪659

מקט	קוטר	מחיר
20 1270u 049	● 49	₪659
20 1270u 050	● 50	₪744
20 1270u 051	● 51	₪744
20 1270u 052	● 52	₪780
20 1270u 053	● 53	₪805
20 1270u 054	● 54	₪831
20 1270u 055	● 55	₪854
20 1270u 056	● 56	₪880
20 1270u 057	● 57	₪901
20 1270u 058	● 58	₪926
20 1270u 059	● 59	₪947
20 1270u 060	● 60	₪974

מקדח חלול HSS-XE לעומק 55 מ"מ





20 1285U

GOLD-DRILLLINE 780

מקדח חלול HSS-XE לעומק 80 מ"מ

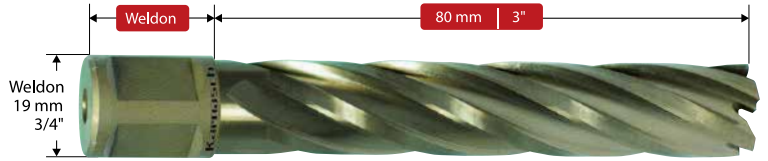
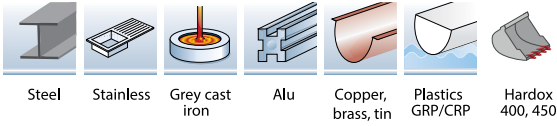

מקט	קוטר	מחיר
201285u018	● 18	₪411
201285u019	● 19	₪411
201285u020	● 20	₪429
201285u021	● 21	₪429
201285u022	● 22	₪488
201285u023	● 23	₪488

מקט	קוטר	מחיר
201285u024	● 24	₪516
201285u025	● 25	₪516
201285u026	● 26	₪534
201285u027	● 27	₪534
201285u028	● 28	₪582
201285u029	● 29	₪582

מקט	קוטר	מחיר
201285u030	● 30	₪611
201285u032	● 32	₪654
201285u033	● 33	₪654
201285u034	● 34	₪760
201285u035	● 35	₪685
201285u036	● 36	₪775

מקט	קוטר	מחיר
201285u038	● 38	₪822
201285u040	● 40	₪900
201285u045	● 45	₪1069
201285u046	● 46	₪825
201285u050	● 50	₪1369



20 1280U

GOLD-DRILLLINE 110

מקדח חלול HSS-XE לעומק 110 מ"מ

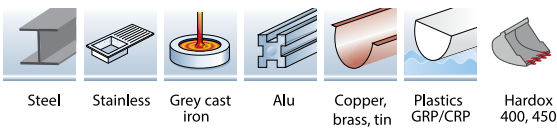

מקט	קוטר	מחיר
201280u018	● 18	₪523
201280u019	● 19	₪536
201280u020	● 20	₪545
201280u021	● 21	₪583
201280u022	● 22	₪596
201280u023	● 23	₪608

מקט	קוטר	מחיר
201280u024	● 24	₪623
201280u025	● 25	₪637
201280u026	● 26	₪701
201280u027	● 27	₪716
201280u028	● 28	₪737
201280u029	● 29	₪759

מקט	קוטר	מחיר
201280u030	● 30	₪788
201280u032	● 32	₪878
201280u033	● 33	₪897
201280u035	● 35	₪937
201280u036	● 36	₪1045
201280u038	● 38	₪1124

מקט	קוטר	מחיר
201280u040	● 40	₪1240
201280u045	● 45	₪1461
201280u050	● 50	₪1792



20 1312

BLUE-DRILL LINE/30

מקדח חלול DURABLUE לעומק 30 מ"מ

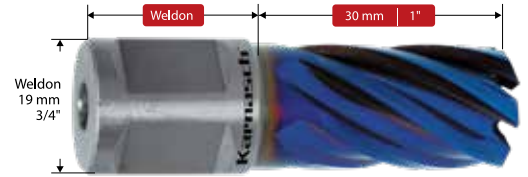
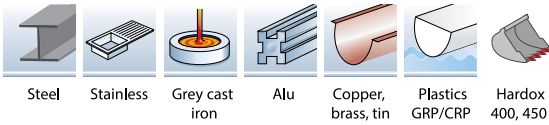

מקט	קוטר	מחיר
20 1312 012	● 12	נח201
20 1312 013	● 13	נח201
20 1312 014	● 14	נח205
20 1312 015	● 15	נח205
20 1312 016	● 16	נח216
20 1312 017	● 17	נח216
20 1312 018	● 18	נח223
20 1312 019	● 19	נח223
20 1312 020	● 20	נח235
20 1312 021	● 21	נח235
20 1312 022	● 22	נח267
20 1312 023	● 23	נח274
20 1312 024	● 24	נח281
20 1312 025	● 25	נח281

מקט	קוטר	מחיר
20 1312 026	● 26	נח294
20 1312 027	● 27	נח294
20 1312 028	● 28	נח318
20 1312 029	● 29	נח318
20 1312 030	● 30	נח330
20 1312 031	● 31	נח386
20 1312 032	● 32	נח408
20 1312 033	● 33	נח408
20 1312 034	● 34	נח430
20 1312 035	● 35	נח430
20 1312 036	● 36	נח478
20 1312 037	● 37	נח588
20 1312 038	● 38	נח614
20 1312 039	● 39	נח614

מקט	קוטר	מחיר
20 1312 040	● 40	נח656
20 1312 041	● 41	נח656
20 1312 042	● 42	נח696
20 1312 043	● 43	נח696
20 1312 044	● 44	נח748
20 1312 045	● 45	נח748
20 1312 046	● 46	נח791
20 1312 047	● 47	נח791
20 1312 048	● 48	נח826
20 1312 049	● 49	נח826
20 1312 050	● 50	נח911
20 1312 051	● 51	נח911
20 1312 052	● 52	נח946
20 1312 053	● 53	נח971

מקט	קוטר	מחיר
20 1312 054	● 54	נח998
20 1312 055	● 55	נח1021
20 1312 056	● 56	נח1047
20 1312 057	● 57	נח1068
20 1312 058	● 58	נח1092
20 1312 059	● 59	נח1114
20 1312 060	● 60	נח1140
20 1312 061	● 61	*
20 1312 062	● 62	*
20 1312 063	● 63	*
20 1312 064	● 64	*



20 1313

BLUE-DRILL LINE/55

מקדח חלול DURABLUE לעומק 55 מ"מ

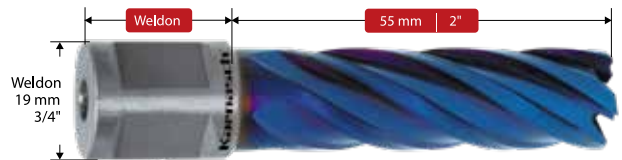
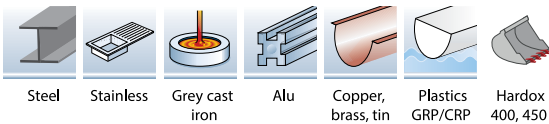

מקט	קוטר	מחיר
20 1313 012	● 12	נח238
20 1313 013	● 13	נח238
20 1313 014	● 14	נח243
20 1313 015	● 15	נח243
20 1313 016	● 16	נח255
20 1313 017	● 17	נח255
20 1313 018	● 18	נח262
20 1313 019	● 19	נח262
20 1313 020	● 20	נח275
20 1313 021	● 21	נח275
20 1313 022	● 22	נח303
20 1313 023	● 23	נח311
20 1313 024	● 24	נח325
20 1313 025	● 25	נח325

מקט	קוטר	מחיר
20 1313 026	● 26	נח347
20 1313 027	● 27	נח347
20 1313 028	● 28	נח371
20 1313 029	● 29	נח371
20 1313 030	● 30	נח386
20 1313 031	● 31	נח386
20 1313 032	● 32	נח408
20 1313 033	● 33	נח408
20 1313 034	● 34	נח430
20 1313 035	● 35	נח430
20 1313 036	● 36	נח478
20 1313 037	● 37	נח588
20 1313 038	● 38	נח614
20 1313 039	● 39	נח614

מקט	קוטר	מחיר
20 1313 040	● 40	נח656
20 1313 041	● 41	נח656
20 1313 042	● 42	נח696
20 1313 043	● 43	נח696
20 1313 044	● 44	נח748
20 1313 045	● 45	נח748
20 1313 046	● 46	נח791
20 1313 047	● 47	נח791
20 1313 048	● 48	נח826
20 1313 049	● 49	נח826
20 1313 050	● 50	נח911
20 1313 051	● 51	נח911
20 1313 052	● 52	נח946
20 1313 053	● 53	נח971

מקט	קוטר	מחיר
20 1313 054	● 54	נח998
20 1313 055	● 55	נח1021
20 1313 056	● 56	נח1047
20 1313 057	● 57	נח1068
20 1313 058	● 58	נח1092
20 1313 059	● 59	נח1114
20 1313 060	● 60	נח1140



\* ניתן להזמין גם בקטרים 18-50 מ"מ לעומקי קידוח 80 מ"מ ו-110 מ"מ.

20 1315

HARD-LINE 40

מקדח חלול שיני ידיה - לעומק 40 מ"מ

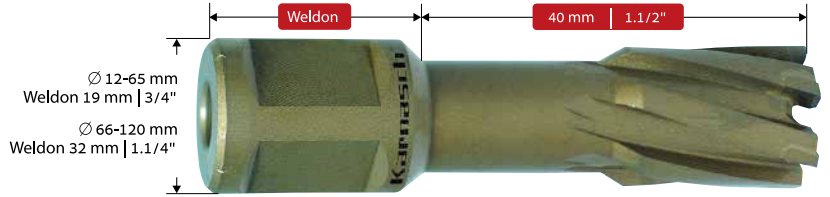
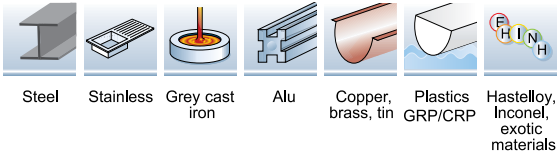

מקט	קוטר	מחיר	מקט	קוטר	מחיר	מקט	קוטר	מחיר	מקט	קוטר	מחיר
20 1315 012	● 12	נח301	20 1315 032	● 32	נח399	20 1315 052	● 52	נח696	20 1315 072	● 72	נח1114
20 1315 013	● 13	נח301	20 1315 033	● 33	נח399	20 1315 053	● 53	נח716	20 1315 073	● 73	נח1128
20 1315 014	● 14	נח311	20 1315 034	● 34	נח399	20 1315 054	● 54	נח740	20 1315 074	● 74	נח1141
20 1315 015	● 15	נח311	20 1315 035	● 35	נח399	20 1315 055	● 55	נח756	20 1315 075	● 75	נח1150
20 1315 016	● 16	נח311	20 1315 036	● 36	נח456	20 1315 056	● 56	נח783	20 1315 076	● 76	נח1220
20 1315 017	● 17	נח311	20 1315 037	● 37	נח457	20 1315 057	● 57	נח802	20 1315 077	● 77	נח1220
20 1315 018	● 18	נח311	20 1315 038	● 38	נח457	20 1315 058	● 58	נח816	20 1315 078	● 78	נח1220
20 1315 019	● 19	נח311	20 1315 039	● 39	נח457	20 1315 059	● 59	נח831	20 1315 079	● 79	נח1220
20 1315 020	● 20	נח311	20 1315 040	● 40	נח457	20 1315 060	● 60	נח845	20 1315 080	● 80	נח1234
20 1315 021	● 21	נח320	20 1315 041	● 41	נח551	20 1315 061	● 61	נח871	20 1315 085	● 85	נח1385
20 1315 022	● 22	נח320	20 1315 042	● 42	נח551	20 1315 062	● 62	נח902	20 1315 090	● 90	נח1600
20 1315 023	● 23	נח320	20 1315 043	● 43	נח551	20 1315 063	● 63	נח935	20 1315 095	● 95	נח1840
20 1315 024	● 24	נח320	20 1315 044	● 44	נח551	20 1315 064	● 64	נח966	20 1315 100	● 100	*
20 1315 025	● 25	נח320	20 1315 045	● 45	נח551	20 1315 065	● 65	נח997	20 1315 105	● 105	*
20 1315 026	● 26	נח338	20 1315 046	● 46	נח592	20 1315 066	● 66	נח994	20 1315 110	● 110	*
20 1315 027	● 27	נח338	20 1315 047	● 47	נח592	20 1315 067	● 67	נח1017	20 1315 115	● 115	*
20 1315 028	● 28	נח338	20 1315 048	● 48	נח592	20 1315 068	● 68	נח1038	20 1315 120	● 120	*
20 1315 029	● 29	נח338	20 1315 049	● 49	נח592	20 1315 069	● 69	נח1053			
20 1315 030	● 30	נח338	20 1315 050	● 50	נח626	20 1315 070	● 70	נח1084			
20 1315 031	● 31	נח399	20 1315 051	● 51	נח680	20 1315 071	● 71	נח1114			

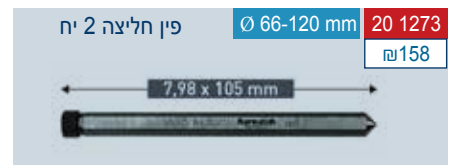
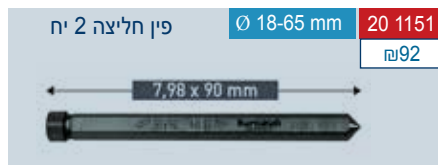
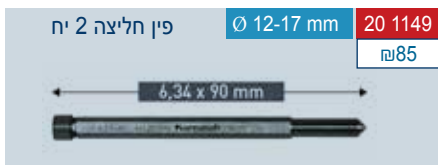

20 1316

HARD-LINE 55

מקדח חלול שיני ידיה - לעומק 55 מ"מ

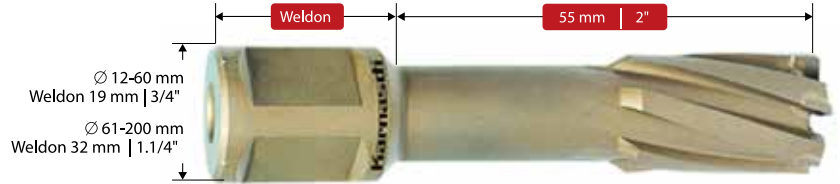
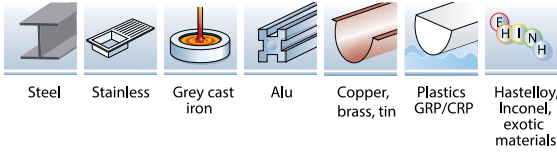

מקט	קוטר	מחיר	מקט	קוטר	מחיר	מקט	קוטר	מחיר	מקט	קוטר	מחיר
201316012	● 12	₪295	201316035	● 35	₪380	201316062	● 62	₪857	201316100	● 100	₪2031
201316013	● 13	₪295	201316036	● 36	₪433	201316063	● 63	₪889	201316103	● 103	₪2201
201316014	● 14	₪295	201316037	● 37	₪434	201316064	● 64	₪918	201316104	● 104	₪2283
201316015	● 15	₪295	201316038	● 38	₪434	201316065	● 65	₪948	201316105	● 105	₪2363
201316016	● 16	₪295	201316039	● 39	₪434	201316066	● 66	₪984	201316106	● 106	₪2446
201316017	● 17	₪295	201316040	● 40	₪434	201316067	● 67	₪1005	201316108	● 108	₪2542
2013160175	● 17.5	₪295	201316041	● 41	₪523	201316068	● 68	₪1026	201316110	● 110	₪2611
201316018	● 18	₪295	201316042	● 42	₪523	201316069	● 69	₪1042	201316115	● 115	₪2933
201316019	● 19	₪295	201316043	● 43	₪523	201316070	● 70	₪1073	201316120	● 120	₪3268
201316020	● 20	₪295	201316044	● 44	₪523	201316071	● 71	₪1085	201316125	● 125	₪3633
201316021	● 21	₪304	201316045	● 45	₪523	201316072	● 72	₪1097	201316130	● 130	₪3995
2013160215	● 21.5	₪304	201316046	● 46	₪563	201316073	● 73	₪1113	201316135	● 135	₪4360
201316022	● 22	₪304	201316047	● 47	₪563	201316074	● 74	₪1132	201316140	● 140	₪4750
201316023	● 23	₪304	201316048	● 48	₪563	201316075	● 75	₪1143	201316145	● 145	₪5127
2013160235	● 23.5	₪304	201316049	● 49	₪563	201316076	● 76	₪1160	201316150	● 150	₪5531
201316024	● 24	₪304	201316050	● 50	₪595	201316077	● 77	₪1175	201316155	● 155	₪5567
201316025	● 25	₪304	201316051	● 51	₪646	201316078	● 78	₪1191	201316160	● 160	₪5633
2013160255	● 25.5	₪304	201316052	● 52	₪661	201316079	● 79	₪1204	201316165	● 165	₪5712
201316026	● 26	₪322	201316053	● 53	₪681	201316080	● 80	₪1222	201316170	● 170	₪5787
201316027	● 27	₪323	201316054	● 54	₪704	201316082	● 82	₪1302	201316175	● 175	₪5927
201316028	● 28	₪323	201316055	● 55	₪719	201316083	● 83	₪1302	201316180	● 180	₪6096
201316029	● 29	₪323	201316056	● 56	₪744	201316084	● 84	₪1347	201316185	● 185	₪6265
201316030	● 30	₪323	201316057	● 57	₪762	201316085	● 85	₪1370	201316190	● 190	₪6435
201316031	● 31	₪380	201316058	● 58	₪776	201316088	● 88	₪1511	201316195	● 195	₪6604
201316032	● 32	₪380	201316059	● 59	₪790	201316090	● 90	₪1585	201316200	● 200	₪6772
201316033	● 33	₪380	201316060	● 60	₪804	201316092	● 92	₪1815			
201316034	● 34	₪380	201316061	● 61	₪857	201316095	● 95	₪1815			

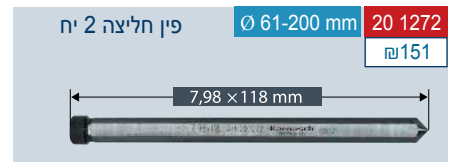
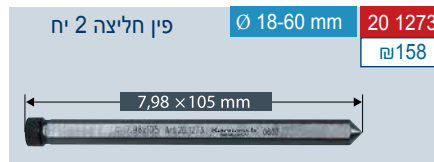
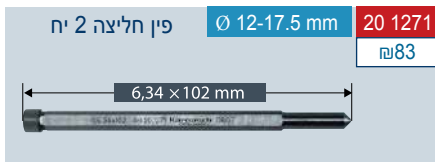



20 1650

**HARD-LINE 80**

מקדח חלול שיני ידיה - לעומק 80 מ"מ

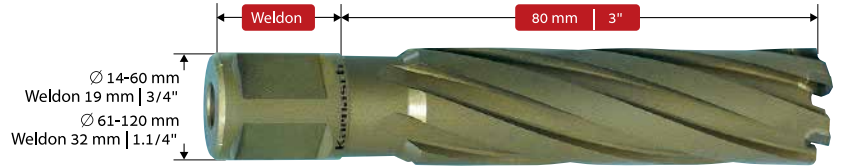
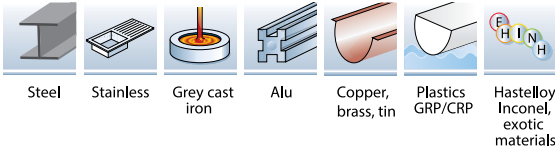

מקט	קוטר	מחיר
201650014	● 14	₪562
201650015	● 15	₪562
201650016	● 16	₪562
201650017	● 17	₪562
201650018	● 18	₪562
201650019	● 19	₪562
201650020	● 20	₪562
201650021	● 21	₪562
201650022	● 22	₪562
201650023	● 23	₪562
201650024	● 24	₪562
201650025	● 25	₪562
201650026	● 26	₪612
201650027	● 27	₪612
201650028	● 28	₪612
201650029	● 29	₪612
201650030	● 30	₪612
201650031	● 31	₪739
201650032	● 32	₪739
201650033	● 33	₪739

מקט	קוטר	מחיר
201650034	● 34	₪739
201650035	● 35	₪739
201650036	● 36	₪843
201650037	● 37	₪843
201650038	● 38	₪843
201650039	● 39	₪843
201650040	● 40	₪843
201650041	● 41	₪1020
201650042	● 42	₪1020
201650043	● 43	₪1020
201650044	● 44	₪1020
201650045	● 45	₪1020
201650046	● 46	₪1163
201650047	● 47	₪1163
201650048	● 48	₪1163
201650049	● 49	₪1163
201650050	● 50	₪1163
201650051	● 51	₪1248
201650052	● 52	₪1248
201650053	● 53	₪1248

מקט	קוטר	מחיר
201650054	● 54	₪1279
201650055	● 55	₪1308
201650056	● 56	₪1402
201650057	● 57	₪1402
201650058	● 58	₪1402
201650059	● 59	₪1429
201650060	● 60	₪1463
201650061	● 61	₪1580
201650062	● 62	₪1580
201650063	● 63	₪1580
201650064	● 64	₪1580
201650065	● 65	₪1580
201650066	● 66	₪1826
201650067	● 67	₪1826
201650068	● 68	₪1826
201650069	● 69	₪1826
201650070	● 70	₪1826
201650072	● 72	₪2034
201650073	● 73	₪2034
201650074	● 74	₪2034

מקט	קוטר	מחיר
201650075	● 75	₪2034
201650076	● 76	₪2121
201650078	● 78	₪2121
201650080	● 80	₪2174
201650082	● 82	₪2296
201650085	● 85	₪2436
201650090	● 90	₪2732
201650095	● 95	₪3124
201650100	● 100	₪3497
201650103	● 103	₪3687
201650104	● 104	₪3758
201650105	● 105	₪3829
201650106	● 106	₪4207
201650108	● 108	₪4088
201650110	● 110	₪4224
201650115	● 115	₪4580
201650120	● 120	₪5104

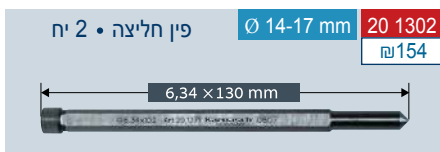

20 1660

**HARD-LINE 110**

מקדח חלול שיני וידיה - לעומק 110 מ"מ

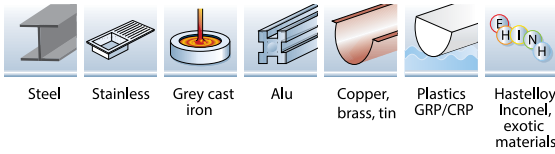

מקט	קוטר	מחיר
201660014	● 14	₪715
201660015	● 15	₪715
201660016	● 16	₪715
201660017	● 17	₪715
201660018	● 18	₪715
201660019	● 19	₪715
201660020	● 20	₪715
201660021	● 21	₪715
201660022	● 22	₪715
201660023	● 23	₪715
201660024	● 24	₪715
201660025	● 25	₪715
201660026	● 26	₪779
201660027	● 27	₪779
201660028	● 28	₪779
201660029	● 29	₪779
201660030	● 30	₪779
201660031	● 31	₪939
201660032	● 32	₪939
201660033	● 33	₪939

מקט	קוטר	מחיר
201660034	● 34	₪939
201660035	● 35	₪939
201660036	● 36	₪1075
201660037	● 37	₪1075
201660038	● 38	₪1075
201660039	● 39	₪1075
201660040	● 40	₪1075
201660041	● 41	₪1298
201660042	● 42	₪1298
201660043	● 43	₪1298
201660044	● 44	₪1298
201660045	● 45	₪1298
201660046	● 46	₪1479
201660047	● 47	₪1479
201660048	● 48	₪1479
201660049	● 49	₪1479
201660050	● 50	₪1479
201660051	● 51	₪1709
201660052	● 52	₪1709
201660053	● 53	₪1709

מקט	קוטר	מחיר
201660054	● 54	₪1709
201660055	● 55	₪1709
201660056	● 56	₪1871
201660057	● 57	₪1871
201660058	● 58	₪1871
201660059	● 59	₪1871
201660060	● 60	₪1871
201660061	● 61	₪2219
201660062	● 62	₪2219
201660063	● 63	₪2219
201660064	● 64	₪2219
201660065	● 65	₪2219
201660066	● 66	₪2465
201660067	● 67	₪2465
201660068	● 68	₪2465
201660069	● 69	₪2465
201660070	● 70	₪2610
201660072	● 72	₪2673
201660073	● 73	₪2704

מקט	קוטר	מחיר
201660074	● 74	₪2732
201660075	● 75	₪2782
201660076	● 76	₪2838
201660078	● 78	₪2918
201660080	● 80	₪2975
201660082	● 82	₪3135
201660085	● 85	₪3333
201660090	● 90	₪3861
201660095	● 95	₪4416
201660100	● 100	₪4947
201660103	● 103	₪5087
201660104	● 104	₪5177
201660105	● 105	₪5241
201660106	● 106	₪5323
201660108	● 108	₪5483
201660110	● 110	₪5587
201660115	● 115	₪6056
201660120	● 120	₪6748

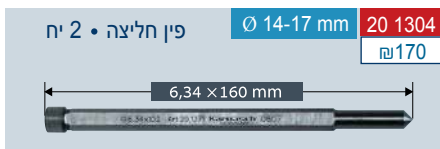

20 1665

HARD-LINE/150

מקדח חלול שיני ידיה - לעומק 150 מ"מ

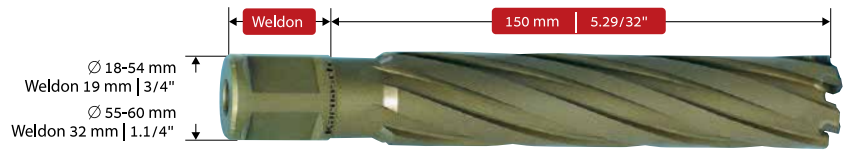
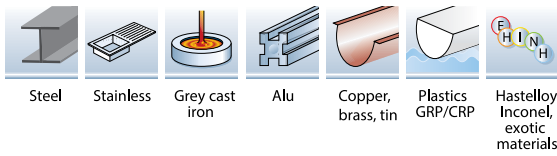

מקט	קוטר	מחיר
201665018	● 18	נח1172
201665019	● 19	נח1172
201665020	● 20	נח1172
201665021	● 21	נח1172
201665022	● 22	נח1172
201665023	● 23	נח1172
201665024	● 24	נח1172
201665025	● 25	נח1172
201665026	● 26	נח1280
201665027	● 27	נח1280
201665028	● 28	נח1280
201665029	● 29	נח1280

מקט	קוטר	מחיר
201665030	● 30	נח1280
201665031	● 31	נח1540
201665032	● 32	נח1540
201665033	● 33	נח1540
201665034	● 34	נח1540
201665035	● 35	נח1540
201665036	● 36	נח1761
201665037	● 37	נח1761
201665038	● 38	נח1761
201665039	● 39	נח1761
201665040	● 40	נח1761
201665041	● 41	נח2063

מקט	קוטר	מחיר
201665042	● 42	נח2063
201665043	● 43	נח2063
201665044	● 44	נח2063
201665045	● 45	נח2063
201665046	● 46	נח2348
201665047	● 47	נח2348
201665048	● 48	נח2063
201665049	● 49	נח2063
201665050	● 50	נח2063
201665051	● 51	נח2314
201665052	● 52	נח2314
201665053	● 53	נח2314

מקט	קוטר	מחיר
201665054	● 54	נח2314
201665055	● 55	נח2314
201665056	● 56	נח2644
201665057	● 57	נח2644
201665058	● 58	נח2644
201665059	● 59	נח2644
201665060	● 60	נח2644



20 1020 EASY-CUT / 5

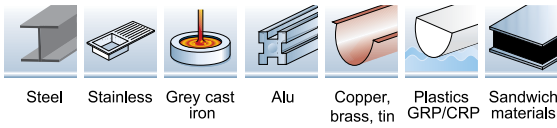

מקדח כוס עם לוחיות מתק"ש  
לנירוסטה לעומק 15 מ"מ



מקט	קוטר	מחיר
20 1020 014	● 14	₪131
20 1020 015	● 15	₪131
20 1020 016	● 16	₪131
20 1020 017	● 17	₪131
20 1020 018	● 18	₪131
20 1020 019	● 19	₪131
20 1020 020	● 20	₪131
20 1020 021	● 21	₪149
20 1020 022	● 22	₪149
20 1020 023	● 23	₪149
20 1020 024	● 24	₪149
20 1020 025	● 25	₪149
20 1020 026	● 26	₪157
20 1020 027	● 27	₪157
20 1020 028	● 28	₪157
20 1020 029	● 29	₪157
20 1020 030	● 30	₪157
20 1020 031	● 31	₪178
20 1020 032	● 32	₪178
20 1020 033	● 33	₪178
20 1020 034	● 34	₪178
20 1020 035	● 35	₪178
20 1020 036	● 36	₪192
20 1020 037	● 37	₪192

מקט	קוטר	מחיר
20 1020 038	● 38	₪192
20 1020 039	● 39	₪192
20 1020 040	● 40	₪192
20 1020 041	● 41	₪211
20 1020 042	● 42	₪211
20 1020 043	● 43	₪211
20 1020 044	● 44	₪211
20 1020 045	● 45	₪211
20 1020 046	● 46	₪225
20 1020 047	● 47	₪225
20 1020 048	● 48	₪225
20 1020 049	● 49	₪225
20 1020 050	● 50	₪225
20 1020 051	● 51	₪254
20 1020 052	● 52	₪254
20 1020 053	● 53	₪254
20 1020 054	● 54	₪254
20 1020 055	● 55	₪254
20 1020 056	● 56	₪282
20 1020 057	● 57	₪282
20 1020 058	● 58	₪282
20 1020 059	● 59	₪282
20 1020 060	● 60	₪282
20 1020 061	● 61	₪302

מקט	קוטר	מחיר
20 1020 062	● 62	₪302
20 1020 063	● 63	₪302
20 1020 064	● 64	₪302
20 1020 065	● 65	₪302
20 1020 066	● 66	₪322
20 1020 067	● 67	₪322
20 1020 068	● 68	₪322
20 1020 069	● 69	₪322
20 1020 070	● 70	₪322
20 1020 071	● 71	₪358
20 1020 072	● 72	₪358
20 1020 073	● 73	₪358
20 1020 074	● 74	₪358
20 1020 075	● 75	₪358
20 1020 076	● 76	₪377
20 1020 077	● 77	₪377
20 1020 078	● 78	₪377
20 1020 079	● 79	₪377
20 1020 080	● 80	₪377
20 1020 085	● 85	₪406
20 1020 090	● 90	₪419
20 1020 095	● 95	₪456
20 1020 100	● 100	₪480
20 1020 105	● 105	₪514

מקט	קוטר	מחיר
20 1020 110	● 110	₪543
20 1020 115	● 115	₪558
20 1020 120	● 120	₪570
20 1020 125	● 125	₪708
20 1020 130	● 130	₪784
20 1020 135	● 135	₪866
20 1020 140	● 140	₪972
20 1020 145	● 145	₪1078
20 1020 150	● 150	₪1216
20 1020 155	● 155	₪1298
20 1020 160	● 160	₪1340
20 1020 165	● 165	₪1381
20 1020 170	● 170	₪1423
20 1020 175	● 175	₪1466
20 1020 180	● 180	₪1508
20 1020 185	● 185	₪1581
20 1020 190	● 190	₪1620
20 1020 195	● 195	₪1669
20 1020 200	● 200	₪1712

20 1130 POWER-MAX SUPER HEAVY-DUTY 30

מקדח כוס עם לוחיות מת"ש  
לנירוסטה וצינורות  
לעומק 30 מ"מ

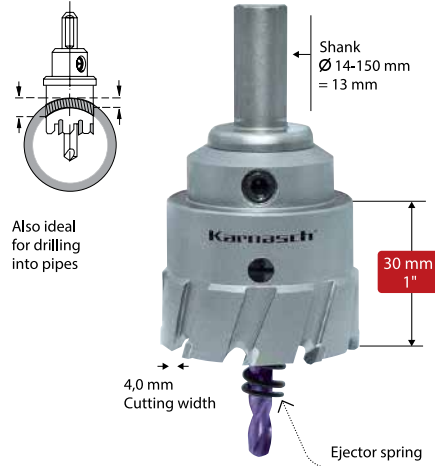
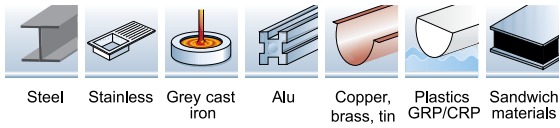

מקט	קוטר	מחיר
201130014	● 14	₪326
2011300145	● 14.5	₪326
201130015	● 15	₪326
201130016	● 16	₪326
2011300165	● 16.5	₪326
201130017	● 17	₪326
201130018	● 18	₪326
2011300185	● 18.5	₪326
201130019	● 19	₪326
201130020	● 20	₪326
2011300205	● 20.5	₪326
201130021	● 21	₪326
201130022	● 22	₪326
2011300225	● 22.5	₪326
201130023	● 23	₪326
201130024	● 24	₪326
201130025	● 25	₪326
2011300255	● 25.5	₪326
201130026	● 26	₪326
201130027	● 27	₪326
201130028	● 28	₪326
201130029	● 29	₪326
201130030	● 30	₪326
2011300305	● 30.5	₪327
201130031	● 31	₪327
201130032	● 32	₪327
2011300325	● 32.5	₪327
201130033	● 33	₪327
201130034	● 34	₪327
201130035	● 35	₪327
201130036	● 36	₪327
201130037	● 37	₪327

מקט	קוטר	מחיר
201130038	● 38	₪327
2011300385	● 38.5	₪327
201130039	● 39	₪327
201130040	● 40	₪327
2011300405	● 40.5	₪358
201130041	● 41	₪358
201130042	● 42	₪358
201130043	● 43	₪358
201130044	● 44	₪359
201130045	● 45	₪359
201130046	● 46	₪365
201130047	● 47	₪365
201130048	● 48	₪365
201130049	● 49	₪365
201130050	● 50	₪365
2011300505	● 50.5	₪365
201130051	● 51	₪365
201130052	● 52	₪365
201130053	● 53	₪369
201130054	● 54	₪369
201130055	● 55	₪369
201130056	● 56	₪441
201130057	● 57	₪441
201130058	● 58	₪441
201130059	● 59	₪441
201130060	● 60	₪441
2011300605	● 60.5	₪481
201130061	● 61	₪487
201130062	● 62	₪487
201130063	● 63	₪487
201130064	● 64	₪487
201130065	● 65	₪487

מקט	קוטר	מחיר
201130066	● 66	₪555
201130067	● 67	₪555
201130068	● 68	₪555
201130069	● 69	₪555
201130070	● 70	₪555
201130071	● 71	₪593
201130072	● 72	₪593
201130073	● 73	₪593
201130074	● 74	₪593
201130075	● 75	₪593
201130076	● 76	₪648
201130077	● 77	₪648
201130078	● 78	₪648
201130079	● 79	₪648
201130080	● 80	₪648
201130081	● 81	₪724
201130082	● 82	₪724
201130083	● 83	₪724
201130084	● 84	₪724
201130085	● 85	₪724
201130086	● 86	₪741
201130087	● 87	₪741
201130088	● 88	₪741
201130089	● 89	₪741
201130090	● 90	₪741
201130091	● 91	₪783
201130092	● 92	₪783
201130093	● 93	₪783
201130094	● 94	₪783
201130095	● 95	₪783
201130096	● 96	₪794
201130097	● 97	₪794

מקט	קוטר	מחיר
201130098	● 98	₪794
201130099	● 99	₪794
201130100	● 100	₪794
201130105	● 105	₪892
201130110	● 110	₪1048
201130115	● 115	₪1227
201130120	● 120	₪1389
201130125	● 125	₪1542
201130130	● 130	₪1692
201130135	● 135	₪1859
201130140	● 140	₪2029
201130145	● 145	₪2215
201130150	● 150	₪2401



20 1141

POWER-MAX SUPER HEAVY-DUTY 55

משור כוס עם לחיות מתק"ש לנירוסטה וצינורות לעומק 55 מ"מ

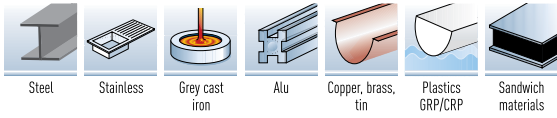

< 1400 N > 900 N > 10% Si

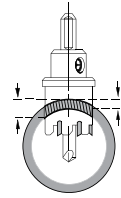

Also ideal for drilling into pipes



מקט	קוטר	מחיר
201141014	• 14	₪474
201141015	• 15	₪474
201141016	• 16	₪474
201141017	• 17	₪474
201141018	• 18	₪474
201141019	• 19	₪474
201141020	• 20	₪474
201141021	• 21	₪474
201141022	• 22	₪474
201141023	• 23	₪474
201141024	• 24	₪474
201141025	• 25	₪474
201141026	• 26	₪474
201141027	• 27	₪474
201141028	• 28	₪474
201141029	• 29	₪474
201141030	• 30	₪474
201141031	• 31	₪475
201141032	• 32	₪475
201141033	• 33	₪475
201141034	• 34	₪475
201141035	• 35	₪475
201141036	• 36	₪475
201141037	• 37	₪475
201141038	• 38	₪475
201141039	• 39	₪475
201141040	• 40	₪475
201141041	• 41	₪519

מקט	קוטר	מחיר
201141042	• 42	₪519
201141043	• 43	₪521
201141044	• 44	₪521
201141045	• 45	₪521
201141046	• 46	₪530
201141047	• 47	₪530
201141048	• 48	₪530
201141049	• 49	₪530
201141050	• 50	₪530
201141051	• 51	₪530
201141052	• 52	₪530
201141053	• 53	₪535
201141054	• 54	₪535
201141055	• 55	₪535
201141056	• 56	₪639
201141057	• 57	₪639
201141058	• 58	₪639
201141059	• 59	₪639
201141060	• 60	₪639
201141061	• 61	₪720
201141062	• 62	₪720
201141063	• 63	₪720
201141064	• 64	₪720
201141065	• 65	₪720
201141066	• 66	₪819
201141067	• 67	₪819
201141068	• 68	₪819
201141069	• 69	₪819

מקט	קוטר	מחיר
201141070	• 70	₪819
201141071	• 71	₪874
201141072	• 72	₪874
201141073	• 73	₪874
201141074	• 74	₪874
201141075	• 75	₪874
201141076	• 76	₪952
201141077	• 77	₪952
201141078	• 78	₪952
201141079	• 79	₪952
201141080	• 80	₪952
201141085	• 85	₪1062
201141090	• 90	₪1088
201141095	• 95	₪1146
201141100	• 100	₪1162
201141105	• 105	₪1293
201141110	• 110	₪1516
201141115	• 115	₪1774
201141120	• 120	₪2008
201141125	• 125	₪2194
201141130	• 130	₪2407
201141135	• 135	₪2643
201141140	• 140	₪2884
201141145	• 145	₪3148
201141150	• 150	₪3412

20 1025

EXTRA EASY-CUT 3

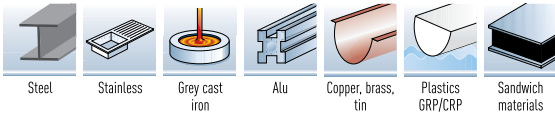

< 1400 N > 900 N > 10% Si

מקט	קוטר	מחיר
201025014	● 14	₪125
201025015	● 15	₪125
201025016	● 16	₪125
201025017	● 17	₪125
201025018	● 18	₪125
201025019	● 19	₪125
201025020	● 20	₪125
201025021	● 21	₪141
201025022	● 22	₪141
201025023	● 23	₪141
201025024	● 24	₪141
201025026	● 26	₪141

מקט	קוטר	מחיר
201025027	● 27	₪141
201025028	● 28	₪152
201025029	● 29	₪152
201025030	● 30	₪152
201025031	● 31	₪169
201025032	● 32	₪169
201025033	● 33	₪169
201025034	● 34	₪169
201025035	● 35	₪169
201025036	● 36	₪183
201025037	● 37	₪183

מקדח כוס עם לוחיות מתק"ש לעומק 8 מ"מ - קנה אימפקט

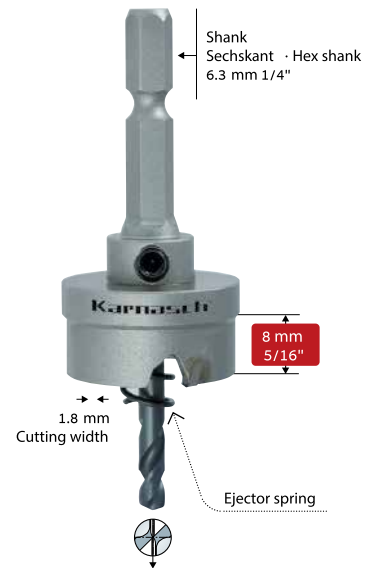

20 1150

ALLROUND ECO 60

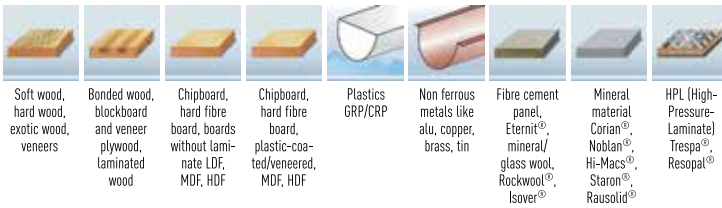

מקט	קוטר	מחיר
201150019	● 19	₪149
201150022	● 20	₪149
201150025	● 25	₪149
201150027	● 27	₪149
201150030	● 30	₪165
201150032	● 32	₪165
201150035	● 35	₪165
201150038	● 38	₪165
201150040	● 40	₪165
201150044	● 44	₪165
201150051	● 51	₪165
201150054	● 54	₪165
201150057	● 57	₪165
201150060	● 60	₪165
201150064	● 64	₪169

מקט	קוטר	מחיר
201150068	● 68	₪179
201150070	● 70	₪179
201150073	● 73	₪183
201150076	● 76	₪204
201150079	● 79	₪216
201150083	● 83	₪225
201150089	● 89	₪234
201150092	● 92	₪255
201150095	● 95	₪262
201150102	● 102	₪323
201150108	● 108	₪354
201150114	● 114	₪363
201150121	● 121	₪395
201150127	● 127	₪403

מקדח כוס עם לוחיות מתק"ש לעומק 60 מ"מ

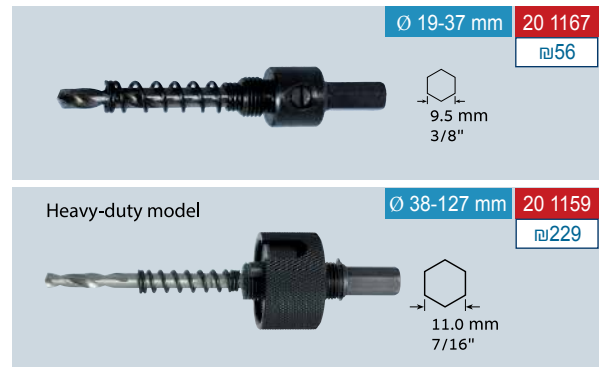

משור כוס מפלדת בי-מטל 8% קובלט

20 1500 BI-METALL COBALT 8%

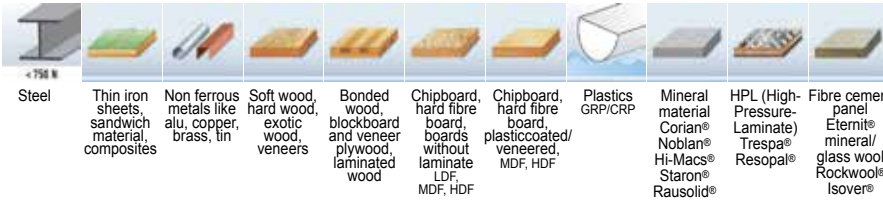

מקט	קוטר	מחיר	מקט	קוטר	מחיר	מקט	קוטר	מחיר	מקט	קוטר	מחיר
20 1500 014	● 14	₪35	20 1500 043	● 43	₪68	20 1500 076	● 76	₪106	20 1500 152	● 152	₪219
20 1500 016	● 16	₪35	20 1500 044	● 44	₪69	20 1500 079	● 79	₪108	20 1500 160	● 160	₪254
20 1500 017	● 17	₪36	20 1500 045	● 45	₪70	20 1500 080	● 80	₪106	20 1500 168	● 168	₪266
20 1500 019	● 19	₪37	20 1500 046	● 46	₪71	20 1500 083	● 83	₪114	20 1500 177	● 177	₪289
20 1500 020	● 20	₪39	20 1500 048	● 48	₪71	20 1500 086	● 86	₪118	20 1500 200	● 200	₪312
20 1500 021	● 21	₪39	20 1500 050	● 50	₪73	20 1500 089	● 89	₪122	20 1500 210	● 210	₪375
20 1500 022	● 22	₪41	20 1500 051	● 51	₪75	20 1500 092	● 92	₪126	20 1500 220	● 220	₪441
20 1500 024	● 24	₪42	20 1500 052	● 52	₪77	20 1500 095	● 95	₪132	20 1500 233	● 233	₪548
20 1500 025	● 25	₪43	20 1500 054	● 54	₪80	20 1500 098	● 98	₪137	20 1500 250	● 250	₪595
20 1500 027	● 27	₪45	20 1500 055	● 55	₪81	20 1500 100	● 100	₪141	20 1500 260	● 260	₪666
20 1500 028	● 28	₪47	20 1500 057	● 57	₪82	20 1500 102	● 102	₪144	20 1500 265	● 265	₪691
20 1500 029	● 29	₪49	20 1500 059	● 59	₪84	20 1500 105	● 105	₪147	20 1500 279	● 279	₪755
20 1500 030	● 30	₪51	20 1500 060	● 60	₪84	20 1500 108	● 108	₪153	20 1500 305	● 305	₪835
20 1500 032	● 32	₪53	20 1500 064	● 64	₪86	20 1500 111	● 111	₪159			
20 1500 033	● 33	₪55	20 1500 065	● 65	₪87	20 1500 114	● 114	₪161			
20 1500 035	● 35	₪58	20 1500 067	● 67	₪94	20 1500 121	● 121	₪170			
20 1500 037	● 37	₪60	20 1500 068	● 68	₪95	20 1500 127	● 127	₪184			
20 1500 038	● 38	₪62	20 1500 070	● 70	₪98	20 1500 133	● 133	₪192			
20 1500 040	● 40	₪64	20 1500 073	● 73	₪103	20 1500 140	● 140	₪200			
20 1500 041	● 41	₪65	20 1500 075	● 75	₪105	20 1500 146	● 146	₪208			



סט כוסות לחשמלאים

20 1501  
₪798

מכיל כוסות:  
Ø22, 29, 35, 44, 51, 64, 68 mm

מחזיקים:  
20 1507 / 20 1521

סט כוסות לשרבר

20 1502  
₪855

מכיל כוסות:  
Ø19, 22, 29, 35, 38, 44, 51, 57, 64 mm

מחזיקים:  
20 1507 / 20 1521

מחזיק כוס קנה SDS

Ø 14-30 mm 20 1510  
₪51

Ø 32-210 mm 20 1511  
₪99

מחזיק כוס קנה משושה

Ø 14-30 mm 20 1507  
₪44

Ø 32-210 mm 20 1503  
₪88

**מחזיק MT עם מעבר לנוזל קירור**



**מחזיק MT החלפה מהירה ציפוי כרום דוחה לכלוך ואבק עם מעבר לנוזל קירור**

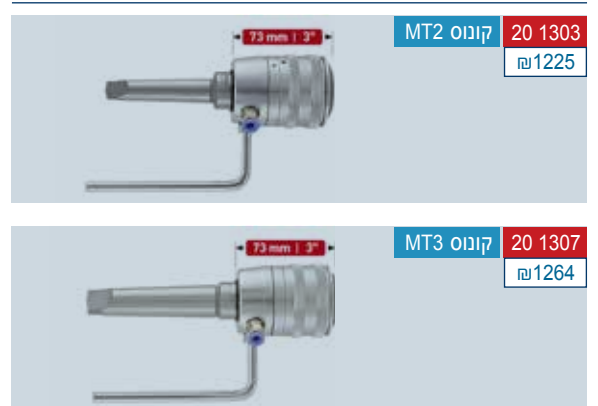

**מתאם לפוטור 3/4-B16**



**פוטור אוטומטי קרנש למקדחים 1-13 כניסה B16**



**מתאם לפוטור B16 - MORSE2**



**פוטור למקדחים 1-13 כניסה B16**

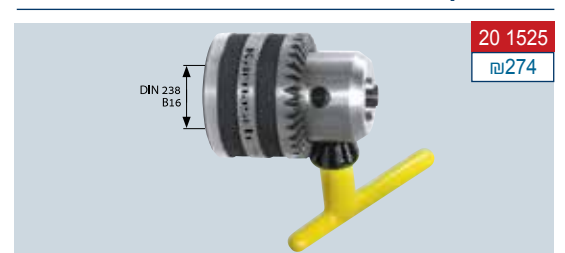

**מתאם לפוטור B16 - MORSE3**



**מאריך 75 מ"מ לקנה 3/4**

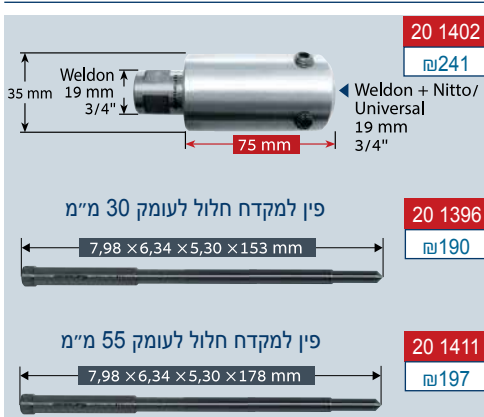

**מתאם למקדחה FEIN**



**מתאם קנה 32 מ"מ ל- 19 מ"מ**



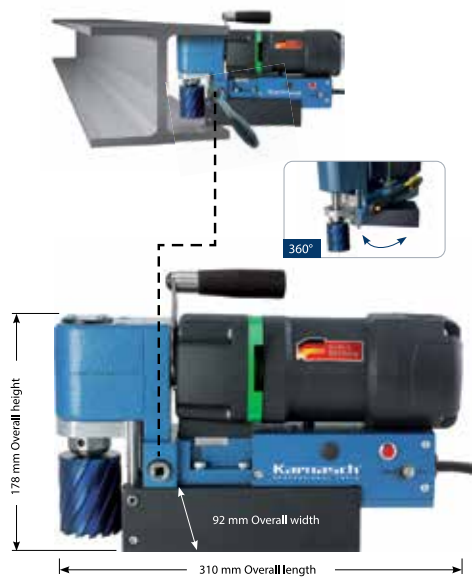

₪10,090

KALP45 BLUE-MAG 208031010

178	גובה המקדחה - מ"מ
12-45	טווח קידוח במקדח חלול - מ"מ
10-30	טווח שיקוע - מ"מ
ללא	יכולת הברזה
55	עומק קידוח מקסימלי - מ"מ
1100	הספק מנוע - WAT
450	סל"ד
תפסן מובנה לכלי	תפיסת המקדח לכלי
63	ציר עליה/ ירידה - מ"מ
1200	כוח מגנט ק"ג
86x196	גודל מגנט מ"מ
ללא	ציר בסיס מסתובב
11	משקל - ק"ג



₪4,612

KALP45 BLUE-MAG 208031010

12-35	טווח קידוח - מ"מ
10-30	טווח שיקוע - מ"מ
ללא	יכולת הברזה
55	עומק קידוח מקסימלי - מ"מ
1100	הספק מנוע - WAT
1000	כוח מגנט ק"ג
ללא	ציר בסיס מסתובב
10.5	משקל - ק"ג



₪7,111

KA40 BLUE-MAG 208021010

12-40	טווח קידוח במקדח חלול - מ"מ
10-30	טווח שיקוע - מ"מ
ללא	יכולת הברזה
110	עומק קידוח מקסימלי - מ"מ
1100	הספק מנוע - WAT
450	סל"ד
תפסן מובנה לכלי	תפיסת המקדח לכלי
170	ציר עליה/ ירידה - מ"מ
1100	כוח מגנט ק"ג
85x170	גודל מגנט מ"מ
ללא	ציר בסיס מסתובב
11.5	משקל - ק"ג





₪9,610

KA50 BLUE-MAG 208023010

12-50	טווח קידוח במקדח חלול - מ"מ
10-40	טווח שיקוע - מ"מ
ללא	יכולת הברזה
110	עומק קידוח מקסימלי - מ"מ
מורס 2	תפיסת המקדח לכלי
1150	WAT - הספק מנוע
1-250 2-450	סל"ד
170	ציר עליה/ ירידה - מ"מ
1250	כוח מגנט ק"ג
85x180	גודל מגנט מ"מ
ללא	ציר בסיס מסתובב
13	משקל ק"ג



₪10,186

KAS50 BLUE-MAG 208024010

12-50	טווח קידוח במקדח חלול - מ"מ
10-40	טווח שיקוע - מ"מ
ללא	יכולת הברזה
110	עומק קידוח מקסימלי - מ"מ
מורס 2	תפיסת המקדח לכלי
1150	WAT - הספק מנוע
1-250 2-450	סל"ד
180	ציר עליה/ ירידה - מ"מ
1250	כוח מגנט ק"ג
85x170	גודל מגנט מ"מ
360	ציר בסיס מסתובב
13.5	משקל - ק"ג



₪10,283

KATV55-BLUE-MAG 208025010

12-55	טווח קידוח במקדח חלול - מ"מ
10-40	טווח שיקוע - מ"מ
M6-M20	יכולת הברזה
110	עומק קידוח מקסימלי - מ"מ
מורס 2	תפיסת המקדח לכלי
1250	WAT - הספק מנוע
1-100-250	סל"ד 1
2-180-450	סל"ד 2
195	ציר עליה/ ירידה - מ"מ
1250	כוח מגנט ק"ג
85x180	גודל מגנט מ"מ
13	משקל - ק"ג



₪10,955

**KATSV55-BLUE MAG208026010**

12-55	טווח קידוח במקדח חלול - מ"מ
10-40	טווח שיקוע - מ"מ
M6-M20	יכולת הברזה
110	עומק קידוח מקסימלי - מ"מ
מורס 2	תפיסת המקדח לכלי
1250	WAT - הספק מנוע
1-100-250	סל"ד 1
2-180-450	סל"ד 2
195	ציר עליה/ ירידה - מ"מ
1250	כוח מגנט ק"ג
85x180	גודל מגנט מ"מ
360 מעלות	ציר בסיס מסתובב
13.5	משקל - ק"ג



₪13,077

**KA100 BLUE-MAG 208027010**

12-100	טווח קידוח במקדח חלול - מ"מ
10-55	טווח שיקוע - מ"מ
ללא	יכולת הברזה
200	עומק קידוח מקסימלי - מ"מ
מורס 3	תפיסת המקדח לכלי
1700	WAT - הספק מנוע
1-110 2-175 3-245 4-385	סל"ד
255	ציר עליה/ ירידה - מ"מ
2050	כוח מגנט ק"ג
102x212	גודל מגנט מ"מ
ללא	ציר בסיס מסתובב
21	משקל - ק"ג



₪30,381

**KATV140-BLUE-MAG 208032010**

12-140	טווח קידוח במקדח חלול - מ"מ
10-80	טווח שיקוע - מ"מ
M6-M44	יכולת הברזה
240	עומק קידוח מקסימלי - מ"מ
מורס 4	תפיסת המקדח לכלי
2300	WAT - הספק מנוע
1-30-80	סל"ד 1
2-50-120	סל"ד 2
3-130-350	סל"ד 3
4-210-550	סל"ד 4
320	ציר עליה/ ירידה - מ"מ
2675	כוח מגנט ק"ג
120x240	גודל מגנט מ"מ
ללא	ציר בסיס מסתובב
35	משקל - ק"ג

חומרי הסיכה של קרנש ידידותיים לסביבה, מאריכים את אורך חיי כלי החיתוך ומיועדים בעיקר למקדחות ללא מיכל נוזל קירור ולקידוחים אנכיים בגובה (סביבת עבודה סטרילית)

60 1159 משחת קירור למקדחים חלולים  
גרם 125



125 g  
Universal cutting-paste  
chlorine free / silicone free

מקט	משקל	כמות	מחיר
601159	גר 125	1 יח	₪120

60 1157 משחת קירור למקדחים חלולים  
גרם 750



750 g  
Universal cutting-paste  
chlorine free /  
silicone free

מקט	משקל	כמות	מחיר
601157	גר 750	1 יח	₪295

60 1200 וקס קירור לקידוח, תברוז, ניסור  
וכרסום 350 גר



מקט	משקל	כמות	מחיר
601200	גר 350	1 יח	₪220

21 0001 מוט מגנטי לפינוי שבבים

₪302





סט מקדחים HSS ו-HSS-CO

HSS	HSS-CO	מספר יח / קפיצה	סט DIN 338
BRB08343100 - נח185	BRB08347100 - נח720	19-pcs 0.5	1-10
BRB08343300 - נח422	BRB08347300 - נח1150	25-pcs 0.5	1-13
BRB08343400 - נח309	BRB08347400 - נח850	50-pcs 0.1	1-5.9
BRB08343500 - נח669	BRB08347500 - נח1800	41-pcs 0.1	6-10



סט קומבי מברזי גאן ומקדחי הכנה M3-M12

מחיר		מקט
נח360	HSS	BRB08303017
נח390	HSS-CO	BRB09100100



שקען 3 שן 90° HSS

מחיר	קוטר	מקט
נח27	4.3	04042043
נח29	6.3	04042063
נח34	8	04042080
נח37	10.4	04042104
נח48	12.4	04042124
נח67	16.5	04042165
נח92	20.5	04042205
נח130	25	04042250
נח188	30	04042300
נח320	40	04042400
נח330	סט 6 יח	B08333400
נח380	סט 6 יח TIN	B08333410



שקען חלול 90 HSS-CO

מחיר	טווח / קוטר	מקט
נח67	6 (2-5)	B04041006
נח99	21 (10-15)	B04041021
נח172	28 (15-20)	B04041028
נח295	32 (15-25)	B04041035
נח580	סט 4 יח	BRB04041000





**סט מקדח מברז משולב  
M3 / M4 / M5 / M6 / M8 / M10**

מק"ט 00708020

**₪ 413**



**סט מברזים ומחרוקות  
יח' 45**

מק"ט 08331030

**₪ 1,080**



**סט מברזים ומחרוקות  
יח' 56**

מק"ט 08331040

**₪ 2,540**



**סט מברזים ומחרוקות  
M3-M24**

מק"ט 08331050

**₪ 3,862**



קוטר	HSS	HSS-CO
0.5	03445005 - רח15	03447005 - רח27
0.6	03445006 - רח15	03447006 - רח27
0.7	03445007 - רח14	03447007 - רח25
0.8	03445008 - רח14	03447008 - רח23
0.9	03445009 - רח14	03447009 - רח23
1	03445010 - רח13	03447010 - רח21
1.1	03445011 - רח14	03447011 - רח23
1.2	03445012 - רח14	03447012 - רח23
1.3	03445013 - רח14	03447013 - רח23
1.4	03445014 - רח14	03447014 - רח21
1.5	03445015 - רח10	03447015 - רח19
1.6	03445016 - רח10	03447016 - רח23
1.7	03445017 - רח10	03447017 - רח23
1.8	03445018 - רח10	03447018 - רח23
1.9	03445019 - רח10	03447019 - רח23
2	03445020 - רח9	03447020 - רח18
2.1	03445021 - רח10	03447021 - רח24
2.2	03445022 - רח10	03447022 - רח23
2.3	03445023 - רח10	03447023 - רח23
2.4	03445024 - רח10	03447024 - רח23
2.5	03445025 - רח9	03447025 - רח19
2.6	03445026 - רח10	03447026 - רח23
2.7	03445027 - רח10	03447027 - רח24
2.8	03445028 - רח10	03447028 - רח24
2.9	03445029 - רח10	03447029 - רח24
3	03445030 - רח9	03447030 - רח19
3.1	03445031 - רח10	03447031 - רח22
3.2	03445032 - רח10	03447032 - רח22
3.3	03445033 - רח10	03447033 - רח22
3.4	03445034 - רח11	03447034 - רח25
3.5	03445035 - רח10	03447035 - רח21
3.6	03445036 - רח12	03447036 - רח27
3.7	03445037 - רח12	03447037 - רח27
3.8	03445038 - רח13	03447038 - רח28
3.9	03445039 - רח13	03447039 - רח28
4	03445040 - רח10	03447040 - רח24
4.1	03445041 - רח13	03447041 - רח27
4.2	03445042 - רח13	03447042 - רח27
4.3	03445043 - רח14	03447043 - רח28
4.4	03445044 - רח14	03447044 - רח28
4.5	03445045 - רח12	03447045 - רח29
4.6	03445046 - רח15	03447046 - רח31
4.7	03445047 - רח15	03447047 - רח31
4.8	03445048 - רח16	03447048 - רח32
4.9	03445049 - רח16	03447049 - רח32
5	03445050 - רח14	03447050 - רח30
5.1	03445051 - רח18	03447051 - רח33
5.2	03445052 - רח18	03447052 - רח33

קוטר	HSS	HSS-CO
5.3	03445053 - רח18	03447053 - רח33
5.4	03445054 - רח20	03447054 - רח35
5.5	03445055 - רח19	03447055 - רח39
5.6	03445056 - רח20	03447056 - רח35
5.7	03445057 - רח20	03447057 - רח35
5.8	03445058 - רח20	03447058 - רח35
5.9	03445059 - רח20	03447059 - רח35
6	03445060 - רח18	03447060 - רח37
6.1	03445061 - רח22	03447061 - רח43
6.2	03445062 - רח22	03447062 - רח43
6.3	03445063 - רח22	03447063 - רח43
6.4	03445064 - רח22	03447064 - רח43
6.5	03445065 - רח20	03447065 - רח41
6.6	03445066 - רח24	03447066 - רח46
6.7	03445067 - רח24	03447067 - רח46
6.8	03445068 - רח26	03447068 - רח50
6.9	03445069 - רח26	03447069 - רח50
7	03445070 - רח24	03447070 - רח44
7.1	03445071 - רח30	03447071 - רח58
7.2	03445072 - רח30	03447072 - רח58
7.3	03445073 - רח30	03447073 - רח58
7.4	03445074 - רח30	03447074 - רח58
7.5	03445075 - רח27	03447075 - רח47
7.6	03445076 - רח34	03447076 - רח68
7.7	03445077 - רח34	03447077 - רח68
7.8	03445078 - רח34	03447078 - רח68
7.9	03445079 - רח34	03447079 - רח68
8	03445080 - רח30	03447080 - רח57
8.1	03445081 - רח40	03447081 - רח74
8.2	03445082 - רח40	03447082 - רח74
8.3	03445083 - רח40	03447083 - רח74
8.4	03445084 - רח40	03447084 - רח74
8.5	03445085 - רח35	03447085 - רח60
8.6	03445086 - רח45	03447086 - רח84
8.7	03445087 - רח45	03447087 - רח84
8.8	03445088 - רח45	03447088 - רח84
8.9	03445089 - רח45	03447089 - רח84
9	03445090 - רח39	03447090 - רח73
9.1	03445091 - רח49	03447091 - רח110
9.2	03445092 - רח49	03447092 - רח110
9.3	03445093 - רח49	03447093 - רח110
9.4	03445094 - רח49	03447094 - רח110
9.5	03445095 - רח44	03447095 - רח89
9.6	03445096 - רח57	03447096 - רח120
9.7	03445097 - רח57	03447097 - רח120
9.8	03445098 - רח57	03447098 - רח120
9.9	03445099 - רח57	03447099 - רח120
10	03445100 - רח48	03447100 - רח86

קוטר	HSS	HSS-CO
10.1	03445101 - רח81	03447101 - רח136
10.2	03445102 - רח81	03447102 - רח136
10.3	03445103 - רח81	03447103 -
10.4	03445104 - רח81	03447104 - רח180
10.5	03445105 - רח56	03447105 - רח125
10.6	03445106 - רח81	03447106 - רח230
10.7	03445107 - רח85	03447107 -
10.8	03445108 - רח85	03447108 -
10.9	03445109 - רח85	03447109 - רח252
11	03445110 - רח65	03447110 - רח134
11.1	03445111 - רח96	03447111 - רח252
11.2	03445112 - רח96	03447112 -
11.3	03445113 - רח96	03447113 - רח294
11.4	03445114 - רח96	03447114 - רח294
11.5	03445115 - רח70	03447115 - רח185
11.6	03445116 - רח102	03447116 -
11.7	03445117 - רח102	03447117 -
11.8	03445118 - רח102	03447118 - רח294
11.9	03445119 - רח105	03447119 -
12	03445120 - רח81	03447120 - רח190
12.1	03445121 - רח135	03447121 -
12.2	03445122 - רח135	03447122 - רח315
12.3	03445123 - רח135	03447123 -
12.4	03445124 - רח135	03447124 -
12.5	03445125 - רח83	03447125 - רח231
12.6	03445126 - רח154	03447126 -
12.7	03445127 - רח154	03447127 - רח315
12.8	03445128 - רח154	03447128 - רח315
12.9	03445129 - רח154	03447129 -
13	03445130 - רח93	03447130 - רח220
13.5	03445135 - רח147	03447135 - רח285
14	03445140 - רח159	03447140 - רח335
14.5	03445145 - רח205	03447145 - רח399
15	03445150 - רח191	03447150 - רח420
15.5	03445155 - רח243	03447155 - רח462
16	03445160 - רח227	03447160 - רח500



מידות	HSS	HSS-CO
13x101x182	03463130 - נח164	03464130 - נח306
13.5x108x189	03463135 - נח173	03464135 - נח323
14x108x189	03463140 - נח182	03464140 - נח340
14.5x114x212	03463145 - נח182	03464145 - נח357
15x114x212	03463150 - נח182	03464150 - נח357
15.5x120x218	03463155 - נח191	03464155 - נח374
16x120x218	03463160 - נח191	03464160 - נח374
16.5x125x223	03463165 - נח200	03464165 - נח390
17x125x223	03463170 - נח209	03464170 - נח390
17.5x130x228	03463175 - נח228	03464175 - נח442
18x130x228	03463180 - נח228	03464180 - נח442
18.5x135x233	03463185 - נח255	03464185 - נח459
19x135x233	03463190 - נח264	03464190 - נח459
19.5x140x238	03463195 - נח291	03464195 - נח510
20x140x238	03463200 - נח291	03464200 - נח510
20.5x145x243	03463205 - נח310	03464205 - נח535
21x145x243	03463210 - נח319	03464210 - נח535
21.5x248x150	03463215 - נח355	03464215 - נח586
22x150x248	03463220 - נח355	03464220 - נח586
22.5x155x253	03463225 - נח401	03464225 - נח697
23x155x253	03463230 - נח419	03464230 - נח697
23.5x155x276	03463235 - נח437	03464235 - נח710
24x160x281	03463240 - נח446	03464240 - נח710
24.5x160x281	03463245 - נח473	03464245 - נח852
25x160x281	03463250 - נח501	03464250 - נח852
25.5x165x286	03463255 - נח528	03464255 - נח915
26x165x286	03463260 - נח546	03464260 - נח915
26.5x265x286	03463265 - נח546	03464265 - נח970
27x170x291	03463270 - נח564	03464270 - נח970
27.5x170x291	03463275 - נח601	03464275 - נח1065
28x170x291	03463280 - נח610	03464280 - נח1065
28.5x175x296	03463285 - נח674	03464285 - נח1112
29x175x296	03463290 - נח683	03464290 - נח1112
29.5x175x296	03463295 - נח701	03464295 - נח1144
30x175x296	03463300 - נח710	03464300 - נח1144
30.5x180x301	03463305 - נח747	03464305 - נח1704
31x180x301	03463310 - נח765	03464310 - נח1704
31.5x180x301	03463315 - נח847	03464315 - נח1704
32x185x334	03463320 - נח874	03464320 - נח1704
32.5x185x334	03463325 - נח947	03464325 - נח1941
33x185x334	03463330 - נח947	03464330 - נח1941
33.5x185x334	03463335 - נח1038	03464335 -
34x190x339	03463340 - נח1038	03464340 - נח2036
34.5x190x339	03463345 - נח1092	03466345 -
35x190x339	03463350 - נח1092	03464350 - נח2036
35.5x190x339	03463355 - נח1202	03464355 -
36x195x344	03463360 - נח1202	03464360 - נח2462
36.5x195x344	03463365 - נח1411	03464365 -
37x195x344	03463370 - נח1411	03464370 - נח2462
37.5x195x344	03463375 - נח1438	03464375 -
38x200x349	03463380 - נח1438	03464380 - נח2462
39x200x349	03463390 - נח1493	03464390 - נח2762

מידות	HSS	HSS-CO
39.5x200x349	03463395 - נח1548	03464395 -
40x200x349	03463400 - נח1548	03464400 - נח2762
40.5x205x354	03463405 - נח1593	03464405 -
41x205x354	03463410 - נח1639	03464410 -
41.5x205x354	03463415 - נח1684	03464415 -
42x205x354	03463420 - נח1730	03464420 -
42.5x205x354	03463425 - נח1775	03464425 -
43x210x359	03463430 - נח1821	03464430 -
43.5x210x359	03463435 - נח1848	03464435 -
44x210x359	03463440 - נח1866	03464440 -
44.5x210x359	03463445 - נח1912	3464445
45x210x359	03463450 - נח1957	03464450 - נח3629
45.5x215x364	03463455 - נח1985	03464455 -
46x215x364	03463460 - נח2030	03464460 -
46.5x215x364	03463465 - נח2094	03464465 -
47x215x364	03463470 - נח2185	03464470 -
47.5x215x364	03463475 - נח2276	03464475 -
48x220x369	03463480 - נח2367	03464480 -
48.5x369x220	03463485 - נח2458	03464485 -
49x220x369	03463490 - נח2549	03464490 -
49.5x220x369	03463495 - נח2640	03464495 -
50x220x369	03463500 - נח2731	03464500 - נח4655
51x225x412	03463510 - נח3642	03464510 -
52x225x412	03463520 - נח3824	03464520 -
53x225x412	03463530 - נח3933	03464530 -
54x230x417	03463540 - נח4097	03464540 -
55x230x417	03463550 - נח4188	03464550 - נח9468
56x230x417	03463560 - נח4479	03464560 -
57x235x422	03463570 - נח4643	03464570 -
58x235x422	03463580 - נח4916	03464580 -
59x235x422	03463590 - נח5371	03464590 -
60x235x422	03463600 - נח5572	03464600 - נח11835



M	מק"ט	מחיר
M 1	00105010	₪79
M 1,1	00105020	₪79
M 1,2	00105030	₪79
M 1,4	00105040	₪79
M 1,6	00105050	₪79
M 1,7	00105060	₪79
M 1,8	00105070	₪79
M 2	00105080	₪62
M 2,2	00105090	₪62
M 2,3	00105100	₪62
M 2,5	00105110	₪62
M 2,6	00105120	₪62
M 3	00105130	₪36
M 3,5	00105140	₪55
M 4	00105150	₪36
M 4,5	00105160	₪59
M 5	00105170	₪39
M 6	00105190	₪46
M 7	00105200	₪97
M 8	00105210	₪63
M 9	00105220	₪110
M 10	00105230	₪71
M 12	00105250	₪95
M 14	00105260	₪149
M 16	00105270	₪173
M 18	00105280	₪250
M 20	00105290	₪266
M 22	00105300	₪366
M 24	00105310	₪416
M 27	00105320	₪520
M 30	00105330	₪1081
M 33	00105340	₪1099
M 36	00105350	₪1497
M 39	00105360	₪1774
M 42	00105370	₪2101
M 45	00105380	₪2465
M 48	00105390	₪3028
M 52	00105400	₪3784
M 56	00105410	₪5109
M 60	00105420	₪6843

NPT	מק"ט	מחיר
NPT 1/16-27	00181010	₪732
NPT 1/8-27	00181020	₪946
NPT 1/4-18	00181030	₪1087
NPT 3/8-18	00181040	₪1342
NPT 1/2-14	00181050	₪1610
NPT 3/4-14	00181060	₪1980
NPT 1-11,5	00181070	₪3034
NPT 1.1/4-11,5	00181080	₪7014
NPT 1.1/2-11,5	00181090	₪9764
NPT 2-11,5	00181100	₪12526
NPT 2.1/2-8	00181110	₪22040
NPT 3-8	00181120	₪28414
NPT 3.1/2-8	00181130	₪39704
NPT 4-8	00181140	₪47813

UNC	מק"ט	מחיר
UNC Nr. 4	00165040	₪106
UNC Nr. 5	00165050	₪65
UNC Nr. 6	00165060	₪65
UNC Nr. 8	00165080	₪70
UNC Nr. 10	00165100	₪70
UNC Nr. 12	00165120	₪83
UNC 1/4	00165130	₪69
UNC 5/16	00165140	₪96
UNC 3/8	00165150	₪108
UNC 7/16	00165160	₪144
UNC 1/2	00165170	₪144
UNC 9/16	00165180	₪253
UNC 5/8	00165190	₪322
UNC 3/4	00165210	₪457
UNC 7/8	00165230	₪551
UNC 1	00165250	₪709
UNC 1.1/8	00165260	₪940
UNC 1.1/4	00165270	₪1624
UNC 1.3/8	00165280	₪2191
UNC 1.1/2	00165290	₪2530

BSP	מק"ט	מחיר
BSP 1/8	00155020	₪122
BSP 1/4	00155060	₪122
BSP 3/8	00155080	₪122
BSP 1/2	00155100	₪168
BSP 5/8	00155120	₪270
BSP 3/4	00155130	₪265
BSP 7/8	00155140	₪541
BSP 1	00155150	₪600
BSP 1.1/8	00155170	₪882
BSP 1.1/4	00155180	₪1093
BSP 1.3/8	00155190	₪1151
BSP 1.1/2	00155200	₪1284
BSP 1.5/8	00155210	₪1508
BSP 1.3/4	00155220	₪1594
BSP 2	00155230	₪2072
BSP 2.1/4	00155240	₪2590
BSP 2.1/2	00155250	₪3313
BSP 2.3/4	00155260	₪12396
BSP 3	00155270	₪11417
BSP 3.1/4	00155280	₪22833
BSP 3.1/2	00155290	₪22833
BSP 3.3/4	00155300	₪26910
BSP 4	00155310	₪26910

UNF	מק"ט	מחיר
UNF Nr. 4	00175040	₪85
UNF Nr. 5	00175050	₪51
UNF Nr. 6	00175060	₪51
UNF Nr. 8	00175080	₪51
UNF Nr. 10	00175100	₪65
UNF Nr. 12	00175120	₪66
UNF 1/4	00175130	₪56
UNF 5/16	00175140	₪78
UNF 3/8	00175150	₪89
UNF 7/16	00175160	₪117
UNF 1/2	00175170	₪117
UNF 9/16	00175180	₪204
UNF 5/8	00175190	₪217
UNF 3/4	00175210	₪307
UNF 7/8	00175230	₪369
UNF 1 (12)	00175260	₪474
UNF 1.1/8	00175270	₪725
UNF 1.1/4	00175280	₪1083
UNF 1.3/8	00175290	₪1461
UNF 1.1/2	00175300	₪1687

BSW	מק"ט	מחיר
BSW 1/16	00135010	₪125
BSW 3/32	00135020	₪125
BSW 1/8	00135030	₪58
BSW 5/32	00135040	₪58
BSW 3/16	00135050	₪63
BSW 7/32	00135060	₪75
BSW 1/4	00135070	₪75
BSW 5/16	00135080	₪104
BSW 3/8	00135090	₪117
BSW 7/16	00135100	₪156
BSW 1/2	00135110	₪156
BSW 9/16	00135120	₪272
BSW 5/8	00135130	₪347
BSW 3/4	00135140	₪616
BSW 7/8	00135150	₪743
BSW 1	00135160	₪912
BSW 1.1/8	00135170	₪1088
BSW 1.1/4	00135180	₪2030
BSW 1.3/8	00135190	₪2738
BSW 1.1/2	00135200	₪3163
BSW 1.5/8	00135210	₪3864
BSW 1.7/8	00135230	₪5928
BSW 2	00135240	₪5494



MF	מק"ט	מחיר
MF 2,5 x 0,35	00115150	₪81
MF 2,6 x 0,35	00115160	₪81
MF 2 x 0,25	00115170	₪81
MF 2 x 0,35	00115180	₪81
MF 3 x 0,35	00115200	₪34
MF 3,5 x 0,35	00115220	₪41
MF 4 x 0,35	00115230	₪34
MF 4 x 0,5	00115240	₪34
MF 4,5 x 0,35	00115250	₪44
MF 4,5 x 0,5	00115260	₪44
MF 5 x 0,35	00115270	₪44
MF 5 x 0,5	00115280	₪37
MF 5 x 0,75	00115290	₪44
MF 5,5 x 0,5	00115300	₪52
MF 5,5 x 0,75	00115310	₪52
MF 6 x 0,5	00115320	₪52
MF 6 x 0,75	00115330	₪44
MF 7 x 0,5	00115350	₪72
MF 7 x 0,75	00115360	₪72
MF 8 x 0,5	00115380	₪72
MF 8 x 0,75	00115390	₪60
MF 8 x 1	00115400	₪60
MF 8 x 1,5	00115410	₪60
MF 9 x 0,5	00115420	₪83
MF 9 x 0,75	00115430	₪83
MF 9 x 1	00115440	₪83
MF 10 x 0,5	00115450	₪83
MF 10 x 0,75	00115460	₪83
MF 10 x 1	00115470	₪69
MF 10 x 1,25	00115480	₪69
MF 11 x 0,5	00115490	₪109
MF 11 x 0,75	00115500	₪109
MF 11 x 1	00115510	₪109
MF 11 x 1,25	00115520	₪109
MF 12 x 0,5	00115530	₪109
MF 12 x 0,75	00115540	₪109
MF 12 x 1	00115550	₪90
MF 12 x 1,25	00115560	₪90
MF 12 x 1,5	00115570	₪90
MF 13 x 0,5	00115580	₪170
MF 13 x 0,75	00115590	₪170
MF 13 x 1	00115600	₪170
MF 13 x 1,25	00115610	₪170
MF 13 x 1,5	00115620	₪170
MF 14 x 0,5	00115630	₪170
MF 14 x 0,75	00115640	₪170
MF 14 x 1	00115650	₪141
MF 14 x 1,25	00115660	₪141
MF 14 x 1,5	00115670	₪141
MF 15 x 0,5	00115680	₪208
MF 15 x 0,75	00115690	₪208
MF 15 x 1	00115700	₪174
MF 15 x 1,25	00115710	₪174
MF 15 x 1,5	00115720	₪174
MF 16 x 0,5	00115730	₪208
MF 16 x 0,75	00115740	₪208
MF 16 x 1	00115750	₪174
MF 16 x 1,25	00115760	₪174
MF 16 x 1,5	00115770	₪174

MF	מק"ט	מחיר
MF 17 x 0,75	00115780	₪285
MF 17 x 1	00115790	₪285
MF 17 x 1,5	00115800	₪285
MF 17 x 2	00115810	₪285
MF 18 x 0,5	00115820	₪285
MF 18 x 0,75	00115830	₪285
MF 18 x 1	00115840	₪237
MF 18 x 1,25	00115850	₪237
MF 18 x 1,5	00115860	₪237
MF 18 x 2	00115870	₪237
MF 19 x 1	00115880	₪341
MF 19 x 1,5	00115900	₪341
MF 20 x 0,5	00115910	₪341
MF 20 x 0,75	00115920	₪341
MF 20 x 1	00115930	₪284
MF 20 x 1,25	00115940	₪284
MF 20 x 1,5	00115950	₪284
MF 20 x 2	00115960	₪284
MF 21 x 1	00115980	₪347
MF 21 x 1,5	00122000	₪347
MF 22 x 0,5	00122010	₪416
MF 22 x 0,75	00122020	₪416
MF 22 x 1	00122030	₪347
MF 22 x 1,25	00122040	₪347
MF 22 x 1,5	00122050	₪347
MF 22 x 2	00122060	₪347
MF 23 x 1	00122070	₪472
MF 23 x 1,5	00122080	₪472
MF 24 x 0,5	00122090	₪472
MF 24 x 0,75	00122100	₪472
MF 24 x 1	00122110	₪393
MF 24 x 1,25	00122120	₪393
MF 24 x 1,5	00122130	₪393
MF 24 x 2	00122140	₪393
MF 25 x 1	00122150	₪589
MF 25 x 1,5	00122170	₪589
MF 25 x 2	00122180	₪490
MF 26 x 1	00122190	₪490
MF 26 x 1,25	00122200	₪490
MF 26 x 1,5	00122210	₪490
MF 26 x 2	00122220	₪490
MF 27 x 1	00122230	₪589
MF 27 x 1,5	00122240	₪589
MF 27 x 2	00122250	₪589
MF 28 x 1	00122260	₪644
MF 28 x 1,5	00122270	₪644
MF 28 x 2	00122280	₪644
MF 30 x 1	00122290	₪644
MF 30 x 1,5	00122300	₪644
MF 30 x 2	00122310	₪644
MF 30 x 3	00122320	₪644
MF 32 x 1	00122330	₪1036
MF 32 x 1,5	00122340	₪1036
MF 32 x 2	00122350	₪1036
MF 32 x 3	00122360	₪1036
MF 33 x 1	00122370	₪1036
MF 33 x 1,5	00122380	₪1036
MF 33 x 2	00122390	₪1036
MF 33 x 3	00122400	₪1036

MF	מק"ט	מחיר
MF 34 x 1	00122410	₪1411
MF 34 x 1,5	00122420	₪1411
MF 34 x 2	00122430	₪1411
MF 34 x 3	00122440	₪1411
MF 35 x 1	00122450	₪1411
MF 35 x 1,5	00122460	₪1411
MF 35 x 2	00122470	₪1411
MF 35 x 3	00122480	₪1411
MF 36 x 1	00122490	₪1411
MF 36 x 1,5	00122500	₪1411
MF 36 x 2	00122510	₪1411
MF 36 x 3	00122520	₪1411
MF 38 x 1	00122530	₪1673
MF 38 x 1,5	00122540	₪1673
MF 38 x 2	00122550	₪1673
MF 38 x 3	00122560	₪1673
MF 39 x 1,5	00122570	₪1673
MF 39 x 2	00122580	₪1673
MF 39 x 3	00122590	₪1673
MF 40 x 1	00122600	₪1981
MF 40 x 1,5	00122610	₪1981
MF 40 x 2	00122620	₪1981
MF 40 x 3	00122630	₪1981
MF 42 x 1,5	00122640	₪1981
MF 42 x 2	00122650	₪1981
MF 42 x 3	00122660	₪1981
MF 42 x 4	00122670	₪1981
MF 45 x 1	00122680	₪2325
MF 45 x 1,5	00122690	₪2325
MF 45 x 2	00122700	₪2325
MF 45 x 3	00122710	₪2325
MF 45 x 4	00122720	₪2325
MF 48 x 1	00122730	₪2856
MF 48 x 1,5	00122740	₪2856
MF 48 x 2	00122750	₪2856
MF 48 x 3	00122760	₪2856
MF 48 x 4	00122770	₪2856
MF 50 x 1	00122780	₪3569
MF 50 x 1,5	00122790	₪3569
MF 50 x 2	00122800	₪3569
MF 50 x 3	00122810	₪3569
MF 50 x 4	00122820	₪3569
MF 52 x 1	00122830	₪3569
MF 52 x 1,5	00122840	₪3569
MF 52 x 2	00122850	₪3569
MF 52 x 3	00122860	₪3569
MF 52 x 4	00122870	₪3569



DIN 1814 ידית אלומיניום למברז

ידית אלומיניום DIN 1814 למברז	למברזים ידניים			אורך ידית	מקט	מחיר
	W	G	M			
0	W 1/16-5/16	-	M1-M8	130	00600020	₪36
1	W 1/16-3/8	-	M1-M10	175	00600030	₪36
1.1/2	W 1/16-1/2	G 1/8	M1-M12	175	00600040	₪27
2	W 5/32-1/2	G 1/8	M4-M12	280	00600050	₪51
3	W 7/32-3/4	G 1/8-1/2	M5-M20	375	00600060	₪72
4	W 7/16-1	G 1/4-3/4	M9-M27	470	00600070	₪147
5	W 1/2-1.1/4	G 1/4-1	M1-M33	700	00600080	₪254



DIN 1814 ידית פלדה למברז

ידית פלדה DIN 1814 למברז	למברזים ידניים			אורך ידית	מקט	מחיר
	W	G	M			
0	W 1/16-5/16	-	M1-M8	130	00602020	₪47
1	W 1/16-3/8	-	M1-M10	180	00602030	₪56
1.1/2	W 1/16-1/2	G 1/8	M1-M12	180	00602040	₪56
2	W 5/32-1/2	G 1/8	M4-M12	280	00602050	₪96
3	W 7/32-3/4	G 1/8-1/2	M5-M20	380	00602060	₪206
4	W 7/16-1	G 1/4-3/4	M9-M27	515	00602070	₪286
5	W 1/2-1.1/4	G 1/4-1	M1-M33	700	00602080	₪523
6	W 3/4-1.5/8	G 1/2-1.1/4	M18-M42	1000	00602090	₪685
7	W 1-2.1/8	G 3/4-1.3/4	M25-M52	1250	00602100	₪1219
8	W 1-2.1/2	G 3/4-3	M25-M68	1250	00602110	₪1639



ידית רצ'ט למברז

ידית רצ'ט למברז	למברז ידני	אורך ידית	מקט	מחיר
1	M3-M10	85	00612020	₪88
2	M5-M12	100	00612030	₪98
10	M3-M10	250	00614020	₪120
20	M5-M12	300	00614030	₪185



M	מק"ט	מחיר
M 1	00402010	₪123
M 1,1	00402020	₪104
M 1,2	00402030	₪104
M 1,4	00402040	₪104
M 1,6	00402050	₪96
M 1,7	00402060	₪96
M 1,8	00402070	₪96
M 2	00402080	₪52
M 2,2	00402090	₪70
M 2,3	00402100	₪70
M 2,5	00402110	₪52
M 2,6	00402120	₪70
M 3	00402130	₪44
M 4	00402150	₪44
M 5	00402170	₪44
M 6	00402190	₪44
M 7	00402200	₪47
M 8	00402210	₪47
M 9	00402220	₪66
M 10	00402230	₪57
M 11	00402240	₪74
M 12	00402250	₪72
M 14	00402260	₪83
M 16	00402270	₪101
M 18	00402280	₪110
M 20	00402290	₪110
M 22	00402300	₪157
M 24	00402310	₪157
M 27	00402320	₪268
M 30	00402330	₪268
M 33	00402340	₪672
M 36	00402350	₪672
M 39	00402360	₪672
M 42	00402370	₪800
M 45	00402380	₪835
M 48	00402390	₪835
M 52	00402400	₪868
M 56	00402410	₪1609
M 60	00402420	₪1643

UNC	מק"ט	מחיר
UNC Nr. 4	00462040	₪84
UNC Nr. 5	00462050	₪84
UNC Nr. 6	00462060	₪84
UNC Nr. 8	00462080	₪84
UNC Nr. 10	00462100	₪74
UNC Nr. 12	00462120	₪84
UNC 1/4	00462130	₪68
UNC 5/16	00462140	₪80
UNC 3/8	00462150	₪95
UNC 7/16	00462160	₪97
UNC 1/2	00462170	₪130
UNC 9/16	00462180	₪135
UNC 5/8	00462190	₪166
UNC 3/4	00462210	₪168
UNC 7/8	00462230	₪228
UNC 1"	00462250	₪258
UNC 1.1/8	00462260	₪356
UNC 1.1/4	00462270	₪356
UNC 1.3/8	00462280	₪356
UNC 1.1/2	00462290	₪770
UNC 1.3/4	00462300	₪1190
UNC 2"	00462310	₪1190

BSW	מק"ט	מחיר
BSW 3/32	00436020	₪79
BSW 1/8	00436030	₪79
BSW 5/32	00436040	₪79
BSW 3/16	00436050	₪79
BSW 7/32	00436060	₪79
BSW 1/4	00436070	₪79
BSW 5/16	00436080	₪79
BSW 3/8	00436090	₪96
BSW 7/16	00436100	₪96
BSW 1/2	00436110	₪106
BSW 9/16	00436120	₪141
BSW 5/8	00436130	₪154
BSW 3/4	00436140	₪175
BSW 7/8	00436150	₪220
BSW 1"	00436160	₪266
BSW 1.1/8	00436170	₪406
BSW 1.1/4	00436180	₪450
BSW 1.3/8	00436190	₪655
BSW 1.1/2	00436200	₪973
BSW 1.5/8	00436210	₪1417
BSW 1.3/4	00436220	₪1996
BSW 1.7/8	00436230	₪1996
BSW 2"	00436240	₪1996

UNF	מק"ט	מחיר
UNF Nr. 4	00472040	₪84
UNF Nr. 5	00472050	₪84
UNF Nr. 6	00472060	₪84
UNF Nr. 8	00472080	₪84
UNF Nr. 10	00472100	₪74
UNF Nr. 12	00472120	₪84
UNF 1/4	00472130	₪68
UNF 5/16	00472140	₪80
UNF 3/8	00472150	₪95
UNF 7/16	00472160	₪130
UNF 1/2	00472170	₪130
UNF 9/16	00472180	₪135
UNF 5/8	00472190	₪166
UNF 3/4	00472210	₪168
UNF 7/8	00472230	₪228
UNF 1" 12	00472260	₪258
UNF 1.1/8	00472270	₪437
UNF 1.1/4	00472280	₪437
UNF 1.3/8	00472290	₪437
UNF 1.1/2	00472300	₪945

BSP	מק"ט	מחיר
BSP 1/8	00452020	₪121
BSP 1/4	00452060	₪121
BSP 3/8	00452080	₪149
BSP 1/2	00452100	₪175
BSP 5/8	00452120	₪234
BSP 3/4	00452130	₪333
BSP 7/8	00452140	₪350
BSP 1	00452150	₪350
BSP 1.1/8	00452170	₪452
BSP 1.1/4	00452180	₪480
BSP 1.3/8	00452190	₪583
BSP 1.1/2	00452200	₪719
BSP 1.5/8	00452210	₪1099
BSP 1.3/4	00452220	₪1100
BSP 2	00452230	₪1928
BSP 2.1/4	00452240	₪2558
BSP 2.1/2	00452250	₪2947
BSP 2.3/4	00452260	₪2947
BSP 3	00452270	₪3614

NPT	מק"ט	מחיר
NPT 1/16	00480010	₪315
NPT 1/8	00480020	₪315
NPT 1/4	00480030	₪325
NPT 3/8	00480040	₪441
NPT 1/2	00480050	₪441
NPT 3/4	00480060	₪735
NPT 1"	00480070	₪945
NPT 1.1/4	00480080	₪1155
NPT 1.1/2	00480090	₪3225
NPT 2"	00480100	₪4115



MF	מק"ט	מחיר
MF 2 x 0,25	00414100	₪104
MF 3 x 0,35	00414200	₪63
MF 3 x 0,5	00414210	
MF 3,5 x 0,35	00414220	₪104
MF 3,5 x 0,5	00414225	₪104
MF 4 x 0,35	00414230	₪63
MF 4 x 0,5	00414240	₪56
MF 4,5 x 0,5	00414260	₪104
MF 5 x 0,5	00414280	₪56
MF 5 x 0,75	00414290	₪56
MF 5 x 0,8	00414291	
MF 5,5 x 0,5	00414300	₪104
MF 5,5 x 0,75	00414310	₪104
MF 6 x 0,5	00414320	₪56
MF 6 x 0,75	00414330	₪54
MF 7 x 0,35	00414340	₪104
MF 7 x 0,5	00414350	₪104
MF 7 x 0,75	00414360	₪76
MF 8 x 0,5	00414380	₪76
MF 8 x 0,75	00414390	₪59
MF 8 x 1	00414400	₪56
MF 8 x 1,5	00414410	₪104
MF 9 x 0,5	00414420	₪104
MF 9 x 0,75	00414430	₪104
MF 9 x 1	00414440	₪104
MF 10 x 0,5	00414450	₪104
MF 10 x 0,75	00414460	₪93
MF 10 x 1	00414470	₪72
MF 10 x 1,25	00414480	₪77
MF 11 x 0,75	00414500	₪149
MF 11 x 1	00414510	₪110
MF 11 x 1,25	00414520	₪110
MF 12 x 0,5	00414530	₪149
MF 12 x 0,75	00414540	₪119
MF 12 x 1	00414550	₪77
MF 12 x 1,25	00414560	₪80
MF 12 x 1,5	00414570	₪80
MF 13 x 1	00414600	₪110
MF 13 x 1,25	00414610	₪149
MF 13 x 1,5	00414620	₪110
MF 14 x 0,5	00414630	₪149
MF 14 x 0,75	00414640	₪149
MF 14 x 1	00414650	₪99

MF	מק"ט	מחיר
MF 14 x 1,25	00414660	₪99
MF 14 x 1,5	00414670	₪93
MF 15 x 1	00414700	₪266
MF 15 x 1,5	00414720	₪266
MF 16 x 0,5	00414730	₪266
MF 16 x 0,75	00414740	₪266
MF 16 x 1	00414750	₪213
MF 16 x 1,25	00414760	₪213
MF 16 x 1,5	00414770	₪213
MF 17 x 1	00414790	₪266
MF 17 x 1,5	00414780	₪266
MF 18 x 0,5	00414820	₪266
MF 18 x 1	00414840	₪213
MF 18 x 1,25	00414850	₪213
MF 18 x 1,5	00414860	₪213
MF 18 x 2	00414870	₪213
MF 18 x 2,5	00414871	₪213
MF 19 x 1	00414880	₪266
MF 19 x 1,5	00414890	₪266
MF 20 x 0,5	00414910	₪299
MF 20 x 0,75	00414920	₪266
MF 20 x 1	00414930	₪213
MF 20 x 1,25	00414940	₪213
MF 20 x 1,5	00414950	₪213
MF 20 x 2	00414960	₪213
MF 21 x 1,5	00415000	₪339
MF 22 x 1	00415030	₪339
MF 22 x 1,25	00415040	₪339
MF 22 x 1,5	00415050	₪339
MF 22 x 2	00415060	₪339
MF 23 x 1	00415070	₪339
MF 23 x 1,5	00415080	₪339
MF 24 x 1	00415110	₪339
MF 24 x 1,25	00415120	₪339
MF 24 x 1,5	00415130	₪339
MF 24 x 2	00415140	₪339
MF 25 x 1	00415150	₪423
MF 25 x 1,5	00415170	₪423
MF 25 x 2	00415180	₪423
MF 26 x 1	00415190	₪315
MF 26 x 1,5	00415210	₪315
MF 26 x 2	00415220	₪656
MF 27 x 1	00415230	₪396

MF	מק"ט	מחיר
MF 27 x 1,5	00415240	₪396
MF 27 x 2	00415250	₪396
MF 28 x 1	00415260	₪735
MF 28 x 1,5	00415270	₪396
MF 28 x 2	00415280	₪396
MF 29 x 1,5	00415285	₪571
MF 30 x 1	00415290	₪396
MF 30 x 1,5	00415300	₪396
MF 30 x 2	00415310	₪396
MF 30 x 3	00415320	₪653
MF 32 x 1	00415330	₪556
MF 32 x 1,5	00415340	₪396
MF 32 x 2	00415350	₪702
MF 33 x 1	00415370	₪556
MF 33 x 1,5	00415380	₪435
MF 33 x 2	00415390	₪435
MF 33 x 3	00415400	₪808
MF 34 x 1	00415410	₪808
MF 34 x 1,5	00415420	₪556
MF 34 x 2	00415430	₪796
MF 35 x 1	00415450	₪808
MF 35 x 1,5	00415460	₪451
MF 35 x 2	00415470	₪702
MF 36 x 1	00415490	₪808
MF 36 x 1,5	00415500	₪454
MF 36 x 2	00415510	₪454
MF 36 x 3	00415520	₪454
MF 38 x 1	00415530	₪1428
MF 38 x 1,5	00415540	₪906
MF 38 x 2	00415550	₪1387
MF 38 x 3	00415560	₪1387
MF 39 x 1,5	00415570	₪609
MF 39 x 2	00415580	₪609
MF 39 x 3	00415590	₪609
MF 40 x 1	00415600	₪1387
MF 40 x 1,5	00415610	₪607
MF 40 x 2	00415620	₪1224
MF 40 x 3	00415630	₪1224
MF 42 x 1,5	00415640	₪624
MF 42 x 2	00415650	₪624
MF 42 x 3	00415660	₪624
MF 45 x 1	00415680	₪1795
MF 45 x 1,5	00415690	₪1036

ידיית מחרוקת מאלומיניום	למברזים דיניים		אורך ידיית	מקט	מחיר
	W	G			
16x5	W1/6-3/32	M1-M2.6	160	08801010	₪41
20x5	W1/8-5/32	M3-M4	195	08801020	₪28
20x7	W3/16-1/4	M4.5-M6	195	08801030	₪41
25x9	W5/16	M7-M9	215	08801040	₪41
30x11	W3/8-7/16	M10-M11	260	08801050	₪48
38x14	W1/2-9/16	M12-M14	315	08801060	₪55
38x10	G1/4	MF12-MF15	315	08801070	₪57
45x18	W5/8-13/16	M16-20	445	08801080	₪92
45x14	G3/8-1/2	MF16-MF20	445	08801090	₪80
55x22	W7/8-1	M22-M24	495	08801100	₪133
55x16	G5/8-3/4	MF22-MF26	495	08801110	₪104
65x25	W1.1/8-1.3/8	M27-M36	630	08801120	₪199
65x18	G7/8-1	MF-27-MF36	630	08801130	₪146



M DIN 371	מק"ט	מחיר
M 2	00302080	₪52
M 2,5	00302110	₪33
M 3	00302130	₪44
M 4	00302150	₪44
M 5	00302170	₪44
M 6	00302190	₪44
M 8	00302210	₪55
M 10	00302230	₪62

M DIN 376	מק"ט	מחיר
M 3	00309130	₪30
M 4	00309150	₪31
M 5	00309170	₪33
M 6	00309190	₪37
M 8	00309210	₪44
M 10	00309230	₪56
M 12	00309250	₪88
M 14	00309260	₪105
M 16	00309270	₪108
M 18	00309280	₪109
M 20	00309290	₪162
M 22	00309300	₪177
M 24	00309310	₪247
M 27	00309320	₪266
M 30	00309330	

UNC	מק"ט	מחיר
UNC Nr. 4	01604040	
UNC Nr. 5	01604050	₪101
UNC Nr. 6	01604060	₪97
UNC Nr. 8	01604080	₪96
UNC Nr. 10	01604100	₪103
UNC Nr. 12	01604120	₪115
UNC 1/4	01604130	₪111
UNC 5/16	01604140	₪125
UNC 3/8	01604150	₪141
UNC 7/16	01604160	₪172
UNC 1/2	01604170	₪185
UNC 9/16	01604180	₪277
UNC 5/8	01604190	₪235
UNC 3/4	01604210	₪318
UNC 7/8	01604230	₪388
UNC 1	01604250	₪505
UNC 1.1/8	01604260	₪607

BSP	מק"ט	מחיר
BSP 1/8	02504020	₪154
BSP 1/4	02504060	₪210
BSP 3/8	02504080	₪257
BSP 1/2	02504100	₪347
BSP 5/8	02504120	₪431
BSP 3/4	02504130	₪549
BSP 7/8	02504140	₪702
BSP 1	02504150	₪768
BSP 1.1/8	02504160	₪1059
BSP 1.1/4	02504180	₪1273
BSP 1.3/8	02504190	
BSP 1.1/2	02504200	₪1764
BSP 1.3/4	02504220	₪2385
BSP 2	02504230	₪2739

UNF	מק"ט	מחיר
UNF Nr. 4	01704040	
UNF Nr. 5	01704050	₪109
UNF Nr. 6	01704060	₪104
UNF Nr. 8	01704080	₪108
UNF Nr. 10	01704100	₪115
UNF Nr. 12	01704120	₪128
UNF 1/4	01704130	₪130
UNF 5/16	01704140	₪129
UNF 3/8	01704150	₪141
UNF 7/16	01704160	₪179
UNF 1/2	01704170	₪172
UNF 9/16	01704180	₪279
UNF 5/8	01704190	₪229
UNF 3/4	01704210	₪313
UNF 7/8	01704230	₪393
UNF 1	01704250	₪530
UNF 1.1/8	01704270	

BSW	מק"ט	מחיר
BSW 1/8	01304030	₪128
BSW 5/32	01304040	₪128
BSW 3/16	01304050	₪99
BSW 1/4	01304070	₪128
BSW 5/16	01304080	₪162
BSW 3/8	01304090	₪184
BSW 7/16	01304100	₪212
BSW 1/2	01304110	₪212
BSW 9/16	01304120	₪323
BSW 5/8	01304130	₪323
BSW 3/4	01304140	₪623
BSW 7/8	01304150	₪757
BSW 1	01304160	₪857
BSW 1.1/8	01304170	₪1224
BSW 1.1/4	01304180	₪1567
BSW 1.3/8	01304190	₪2336
BSW 1.1/2	01304200	₪2336

MF	מק"ט	מחיר
MF 3 x 0,35	02204260	₪145
MF 4 x 0,5	02204270	₪145
MF 5 x 0,5	02204280	₪145
MF 5 x 0,75	02204290	₪169
MF 6 x 0,5	02204320	₪146
MF 6 x 0,75	02204330	₪144
MF 7 x 0,75	02204340	₪158
MF 8 x 0,5	02204350	₪169
MF 8 x 0,75	02204390	₪161
MF 8 x 1	02204400	₪146
MF 9 x 1	02204440	₪169
MF 10 x 0,75	02204460	₪209
MF 10 x 1	02204470	₪153
MF 10 x 1,25	02204480	₪191
MF 11 x 1	02204510	₪270
MF 11 x 1,25	02204520	₪270
MF 12 x 0,75	02204540	₪270
MF 12 x 1	02204550	₪177
MF 12 x 1,25	02204560	₪199
MF 12 x 1,5	02204570	₪166
MF 13 x 1	02204600	₪337
MF 13 x 1,5	02204620	₪337
MF 14 x 0,75	02204640	₪337
MF 14 x 1	02204650	₪235

MF	מק"ט	מחיר
MF 14 x 1,25	02204660	₪223
MF 14 x 1,5	02204670	₪222
MF 15 x 1	02204700	₪279
MF 15 x 1,5	02204720	₪358
MF 16 x 1	02204750	₪265
MF 16 x 1,25	02204760	₪370
MF 16 x 1,5	02204770	₪252
MF 18 x 1	02204840	₪341
MF 18 x 1,25	02204850	₪471
MF 18 x 1,5	02204860	₪312
MF 18 x 2	02204870	₪350
MF 20 x 1	02204930	₪367
MF 20 x 1,25	02204940	₪528
MF 20 x 1,5	02204950	₪350
MF 20 x 2	02204960	₪477
MF 21 x 1,5	02204980	₪528
MF 22 x 1	02206030	₪510
MF 22 x 1,25	02206040	₪651
MF 22 x 1,5	02206050	₪372
MF 22 x 2	02206060	₪510
MF 23 x 1,5	02206080	₪752
MF 24 x 1	02206110	₪544
MF 24 x 1,25	02206120	₪752
MF 24 x 1,5	02206130	₪408

MF	מק"ט	מחיר
MF 24 x 1	02206110	₪544
MF 24 x 1,25	02206120	₪752
MF 24 x 1,5	02206130	₪408
MF 24 x 2	02206140	₪458
MF 25 x 1	02206150	₪802
MF 25 x 1,5	02206170	₪802
MF 26 x 1	02206200	₪802
MF 26 x 1,5	02206210	₪802
MF 26 x 2	02206220	₪802
MF 27 x 1	02206230	₪929
MF 27 x 1,5	02206240	₪929
MF 27 x 2	02206250	₪929
MF 28 x 1	02206260	₪929
MF 28 x 1,5	02206270	₪929
MF 28 x 2	02206280	₪929
MF 30 x 1	02206290	₪1077
MF 30 x 1,5	02206300	₪1077
MF 30 x 2	02206310	₪1077
MF 30 x 3	02206320	₪1077
MF 32 x 1,5	02206340	₪1318
MF 32 x 2	02206350	₪1318
MF 32 x 3	02206360	₪1318
MF 33 x 1,5	02206380	₪1318
MF 33 x 2	02206390	₪1318



GSR  ACCUD  felo  UNIOR®  morrisflex



ספק  
משהב"ט



טל': 03-6822084, 03-6820720, פקס: 03-6819088  
[info@mataraso.co.il](mailto:info@mataraso.co.il) [WWW.MATARASO.CO.IL](http://WWW.MATARASO.CO.IL)

המחירים מומלצים לא כוללים מע"מ | ט.ל.ח